



**AAMA 507-07 THERMAL PERFORMANCE REPORT**

**Rendered to:**

**TUBELITE, INC.**

**SERIES/MODEL: Standard 2" Wide Stile Single Door**

**TYPE: Swinging Door - Double**

**Report No: B3772.03-116-45**  
**Report Date: 10/27/11**

## AAMA 507-07 THERMAL PERFORMANCE REPORT

Rendered to:

TUBELITE, INC.  
4878 Mackinaw Trail  
Reed City, Michigan 49677

Report No: B3772.03-116-45  
Report Date: 10/27/11  
Simulation Date: 10/27/11

### Project Summary:

Architectural Testing, Inc. was contracted by Tubelite, Inc. to provide U-Factor and Solar Heat Gain Coefficient thermal performance ratings on the Standard 2" Wide Stile Single Door Swinging Door - Double. The thermal performance ratings were determined in accordance with AAMA 507-07, Standard Practice for Determining the Thermal Performance Characteristics of Fenestration Systems Installed in Commercial Building.

### Reference Documents:

*AAMA 507-07, Standard Practice for Determining the Thermal Performance Characteristics of Fenestration Systems Installed in Commercial Buildings*

*NFRC 100-2010, Procedure for Determining Fenestration Product U-Factors*

*NFRC 200-2010, Procedure for Determining Fenestration Product Solar Heat Gain Coefficient and Visible Transmittance at Normal Incidence*

### Simulation Specimen Description:

**Series/Model:** Standard 2" Wide Stile Single Door  
**Product Groupings:** 2" Wide w/o sweep grouped with 2" Wide w/ sweep.  
**Type:** Swinging Door - Double  
**Frame Material:** Aluminum Framing System  
**Material Finish:** Painted Aluminum  
**Specimen Size:** 1920mm wide by 2090mm high (75-1/2" by 82-3/8")  
**Configuration:** Two vision lites separated by one intermediate vertical  
**Drawing Reference:** Tubelite Standard Doors - 2" Frame Details

**Tubelite, Inc.**  
**Standard 2" Wide Stile Single Door - Swinging Door - Double**

**System U-Factor vs. Percentage of Vision Area**

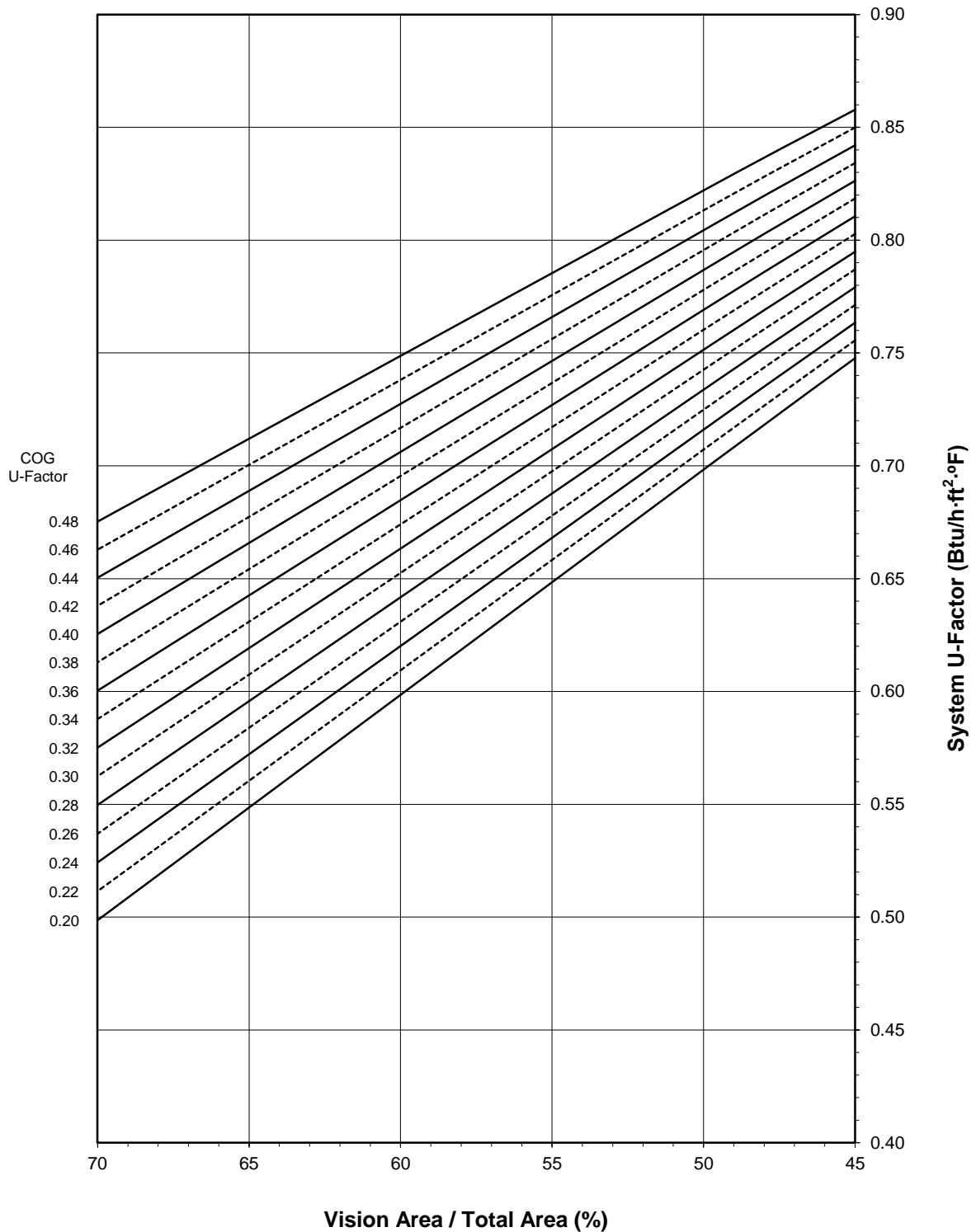

Note: 1 inch Overall - Dual Glazed Glass (0.48-0.20 COG) with Aluminum Spacer



**Tubelite, Inc.**  
**Standard 2" Wide Stile Single Door - Swinging Door - Double**

**Size Specific U-Factor Matrix\***

Glazing Option	Center of Glass U-Factor	Overall U-Factor
1	0.48	0.83
2	0.46	0.82
3	0.44	0.81
4	0.42	0.80
5	0.40	0.79
6	0.38	0.78
7	0.36	0.77
8	0.34	0.76
9	0.32	0.76
10	0.30	0.75
11	0.28	0.74
12	0.26	0.73
13	0.24	0.72
14	0.22	0.71
15	0.20	0.70

Note: 1 inch Overall - Dual Glazed Glass (0.48-0.20 COG) with Aluminum Spacer

**Size Specific SHGC Matrix\***

Center of Glass SHGC	Overall SHGC
0.75	0.42
0.70	0.39
0.65	0.37
0.60	0.34
0.55	0.32
0.50	0.29
0.45	0.27
0.40	0.24
0.35	0.22
0.30	0.19
0.25	0.17
0.20	0.14
0.15	0.12
0.10	0.09
0.05	0.07

**Size Specific VT Matrix\***

Center of Glass VT	Overall VT
0.75	0.37
0.70	0.35
0.65	0.32
0.60	0.30
0.55	0.27
0.50	0.25
0.45	0.22
0.40	0.20
0.35	0.17
0.30	0.15
0.25	0.12
0.20	0.10
0.15	0.07
0.10	0.05
0.05	0.02

\*Size Specific U-Factor, SHGC, and VT Matrices are based on the standard Swinging Door - Double specimen size of 1920mm wide by 2090mm high (75-1/2" by 82-3/8"). This represents 49.6% Vision Area / Total Area.

Vision Area Data

Option No.	COG U-Factor	COG Temperature	Cross Section	Frame Height	Frame U-Factor	Edge U-Factor	Total Product U-Factor		
							45% Vision Area	NFRC 100-2010	70% Vision Area
							68.19" by 74.22"	75.59" by 82.28"	135.57" by 147.57"
1	0.48	43.7	Ext. Head	8.2145	1.1967	0.5769	0.8578	0.8253	0.6753
			Int. Head	8.2145	1.1967	0.5769			
			Ext. Jamb	8.1557	1.1768	0.5786			
			Int. Jamb	8.1557	1.1768	0.5786			
			Mtg. Rail	12.4279	1.0776	0.5801			
			Ext. Sill	8.2770	1.1346	0.5812			
			Int. Sill	8.2770	1.1346	0.5812			
2	0.46	44.8	Ext. Head	8.2145	1.1967	0.5633	0.8499	0.8165	0.6629
			Int. Head	8.2145	1.1967	0.5633			
			Ext. Jamb	8.1557	1.1768	0.5650			
			Int. Jamb	8.1557	1.1768	0.5650			
			Mtg. Rail	12.4279	1.0774	0.5664			
			Ext. Sill	8.2770	1.1344	0.5675			
			Int. Sill	8.2770	1.1344	0.5675			
3	0.44	45.8	Ext. Head	8.2145	1.1966	0.5497	0.8421	0.8078	0.6504
			Int. Head	8.2145	1.1966	0.5497			
			Ext. Jamb	8.1557	1.1767	0.5515			
			Int. Jamb	8.1557	1.1767	0.5515			
			Mtg. Rail	12.4279	1.0772	0.5528			
			Ext. Sill	8.2770	1.1343	0.5539			
			Int. Sill	8.2770	1.1343	0.5539			
4	0.42	46.8	Ext. Head	8.2145	1.1965	0.5363	0.8342	0.7991	0.6380
			Int. Head	8.2145	1.1965	0.5363			
			Ext. Jamb	8.1557	1.1767	0.5381			
			Int. Jamb	8.1557	1.1767	0.5381			
			Mtg. Rail	12.4279	1.0771	0.5393			
			Ext. Sill	8.2770	1.1342	0.5404			
			Int. Sill	8.2770	1.1342	0.5404			
5	0.40	47.9	Ext. Head	8.2145	1.1965	0.5229	0.8263	0.7903	0.6255
			Int. Head	8.2145	1.1965	0.5229			
			Ext. Jamb	8.1557	1.1766	0.5248			
			Int. Jamb	8.1557	1.1766	0.5248			
			Mtg. Rail	12.4279	1.0769	0.5259			
			Ext. Sill	8.2770	1.1341	0.5270			
			Int. Sill	8.2770	1.1341	0.5270			
6	0.38	48.9	Ext. Head	8.2145	1.1965	0.5098	0.8185	0.7816	0.6130
			Int. Head	8.2145	1.1965	0.5098			
			Ext. Jamb	8.1557	1.1766	0.5116			
			Int. Jamb	8.1557	1.1766	0.5116			
			Mtg. Rail	12.4279	1.0767	0.5127			
			Ext. Sill	8.2770	1.1340	0.5136			
			Int. Sill	8.2770	1.1340	0.5136			

Vision Area Data

Option No.	COG U-Factor	COG Temperature	Cross Section	Frame Height	Frame U-Factor	Edge U-Factor	Total Product U-Factor		
							45% Vision Area	NFRC 100-2010	70% Vision Area
							68.19" by 74.22"	75.59" by 82.28"	135.57" by 147.57"
7	0.36	50.0	Ext. Head	8.2145	1.1964	0.4965	0.8106	0.7728	0.6004
			Int. Head	8.2145	1.1964	0.4965			
			Ext. Jamb	8.1557	1.1765	0.4984			
			Int. Jamb	8.1557	1.1765	0.4984			
			Mtg. Rail	12.4279	1.0766	0.4994			
			Ext. Sill	8.2770	1.1338	0.5002			
			Int. Sill	8.2770	1.1338	0.5002			
8	0.34	51.0	Ext. Head	8.2145	1.1963	0.4834	0.8028	0.7641	0.5878
			Int. Head	8.2145	1.1963	0.4834			
			Ext. Jamb	8.1557	1.1765	0.4853			
			Int. Jamb	8.1557	1.1765	0.4853			
			Mtg. Rail	12.4279	1.0764	0.4863			
			Ext. Sill	8.2770	1.1337	0.4872			
			Int. Sill	8.2770	1.1337	0.4872			
9	0.32	52.0	Ext. Head	8.2145	1.1963	0.4703	0.7949	0.7553	0.5752
			Int. Head	8.2145	1.1963	0.4703			
			Ext. Jamb	8.1557	1.1765	0.4721			
			Int. Jamb	8.1557	1.1765	0.4721			
			Mtg. Rail	12.4279	1.0763	0.4731			
			Ext. Sill	8.2770	1.1336	0.4740			
			Int. Sill	8.2770	1.1336	0.4740			
10	0.30	53.1	Ext. Head	8.2145	1.1963	0.4573	0.7870	0.7466	0.5625
			Int. Head	8.2145	1.1963	0.4573			
			Ext. Jamb	8.1557	1.1764	0.4592			
			Int. Jamb	8.1557	1.1764	0.4592			
			Mtg. Rail	12.4279	1.0761	0.4601			
			Ext. Sill	8.2770	1.1335	0.4610			
			Int. Sill	8.2770	1.1335	0.4610			
11	0.28	54.2	Ext. Head	8.2145	1.1962	0.4443	0.7792	0.7378	0.5497
			Int. Head	8.2145	1.1962	0.4443			
			Ext. Jamb	8.1557	1.1764	0.4462			
			Int. Jamb	8.1557	1.1764	0.4462			
			Mtg. Rail	12.4279	1.0760	0.4471			
			Ext. Sill	8.2770	1.1334	0.4479			
			Int. Sill	8.2770	1.1334	0.4479			
12	0.26	55.2	Ext. Head	8.2145	1.1962	0.4314	0.7713	0.7290	0.5370
			Int. Head	8.2145	1.1962	0.4314			
			Ext. Jamb	8.1557	1.1764	0.4333			
			Int. Jamb	8.1557	1.1764	0.4333			
			Mtg. Rail	12.4279	1.0758	0.4341			
			Ext. Sill	8.2770	1.1333	0.4349			
			Int. Sill	8.2770	1.1333	0.4349			

Vision Area Data

Option No.	COG U-Factor	COG Temperature	Cross Section	Frame Height	Frame U-Factor	Edge U-Factor	Total Product U-Factor		
							45% Vision Area	NFRC 100-2010	70% Vision Area
							68.19" by 74.22"	75.59" by 82.28"	135.57" by 147.57"
13	0.24	56.3	Ext. Head	8.2145	1.1962	0.4185	0.7634	0.7203	0.5243
			Int. Head	8.2145	1.1962	0.4185			
			Ext. Jamb	8.1557	1.1763	0.4205			
			Int. Jamb	8.1557	1.1763	0.4205			
			Mtg. Rail	12.4279	1.0757	0.4212			
			Ext. Sill	8.2770	1.1332	0.4220			
			Int. Sill	8.2770	1.1332	0.4220			
14	0.22	57.3	Ext. Head	8.2145	1.1962	0.4058	0.7556	0.7115	0.5115
			Int. Head	8.2145	1.1962	0.4058			
			Ext. Jamb	8.1557	1.1763	0.4077			
			Int. Jamb	8.1557	1.1763	0.4077			
			Mtg. Rail	12.4279	1.0756	0.4084			
			Ext. Sill	8.2770	1.1331	0.4092			
			Int. Sill	8.2770	1.1331	0.4092			
15	0.20	58.4	Ext. Head	8.2145	1.1962	0.3930	0.7477	0.7027	0.4987
			Int. Head	8.2145	1.1962	0.3930			
			Ext. Jamb	8.1557	1.1763	0.3949			
			Int. Jamb	8.1557	1.1763	0.3949			
			Mtg. Rail	12.4279	1.0754	0.3955			
			Ext. Sill	8.2770	1.1331	0.3963			
			Int. Sill	8.2770	1.1331	0.3963			



Detailed drawings, datasheets, representative samples of test specimens, a copy of this report, or other pertinent project documentation will be retained by Architectural Testing, Inc. for a period of four years from the original test date. At the end of this retention period such materials shall be discarded without notice and the service life of this report by Architectural Testing will expire. Results obtained are simulated values and were secured by using the designated test methods. This report does not constitute certification of this product nor an opinion or endorsement by this laboratory. It is the exclusive property of the client named herein and relates only to the specimen(s) simulated. This report may not be reproduced, except in full, without the written approval of Architectural Testing, Inc.

For ARCHITECTURAL TESTING, INC.:

SIMULATED BY:

REVIEWED BY:

---

Eric Barilar  
Simulation Technician

---

Kevin S. Louder  
Project Engineer

EAB:EAB  
B3772.03-116-45

Attachments (pages): This report is complete only when all attachments listed are included.

Appendix A: Drawings and Bills of Material (23)

### Revision Log

<u>Rev. #</u>	<u>Date</u>	<u>Page(s)</u>	<u>Revision(s)</u>
.01R0	10/27/2011	All	Original Report Issue

All drawings and Bills of Material used in simulating this product are enclosed in this Appendix.

## STANDARD PAIR DOOR BOM -2" Frame

**ATI**

**Report #** B3772-116-45

**Date** 10/20/2011

**Simulator** *Eric Barilko*

### FRAME:

Description	QTY	Length	Part number	Material
Jamb 2" x 4 1/2"	2		E14144	
Header 2" x 4 1/2"	1		E14124	
Door stops	3		E4531	
Weather pile	30 ft		P1098A	vinyl
closure open back plate	2		E4543	

### DOOR:

Description	QTY	Narrow P/N	Medium P/N	Wide P/N	Material
Beveled Door Stiles	2	E0055 - 2 1/8"	E0086 - 4"	E0416 - 5"	
Inactive Stile		E0056 - 2 1/8"	E0087 - 4"	E0417 - 5"	
Astragal Stile		E1149 - 2 1/8"	E1150 - 4"	E1151 - 5"	
Adjustable Astragal	1	E1152	E1152	E1152	
Stainless Steel Clip for Adj. Astragal	1	P1539	P1539	P1539	Stainless steel
Adj. Astragal Pile	2	P938	P938	P938	AL
Door Top Rail	1	E0255 - 2 1/8"	E0054 - 4"	E0318 - 5"	
Top Rail Lug	2	P168	P031	P339	AL
Door Botom Rail	1	E0054 - 4"	E0419 - 6 1/2"	E0419 - 6 1/2"	
Bottom Rail Lug	2	P031	P341	P341	AL
Top Rail & Bottom Rail Tie Rods	2	P020	P020	P020	steel
Washer for Tie Rods	4	P853	P853	P853	AL
Hex nuts for Tie rods	4	S071A	S071A	S071A	steel
Exterior Glass Stop 1" glass	4	E0927	E0927	E0927	

Interior Glass Stop 1" glass 4  
 Gasket 36 ft  
 Adjustable Wedge Setting Blck 2  
 Self Adhesive Setting Blck 3

Threshold 1  
 Threshold clip 2

~~E0928~~  
~~P0017~~  
~~P1911~~  
~~P1912~~  
~~E0019~~  
~~P679~~

~~E0928~~  
~~P0017~~  
~~P1911~~  
~~P1912~~  
~~E0019~~  
~~P679~~

E0928  
 P0017 vinyl  
 P1911 Polypropylene  
 P1912 EPDM  
  
 E0019  
 P679 AL

**MATERIAL:**

**E - All E part numbers are AL extrusions**

<b>ATI</b>	
<b>Report #</b>	<u>B3772-116-45</u>
<b>Date</b>	<u>10/20/2011</u>
<b>Simulator</b>	<u><i>Eric Barthe</i></u>

# Standard Doors - Jamb detail 2" Frame

Elevations & 1/4 Size Details

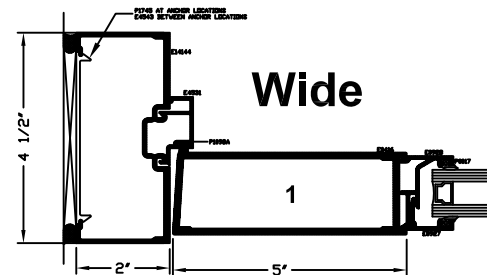
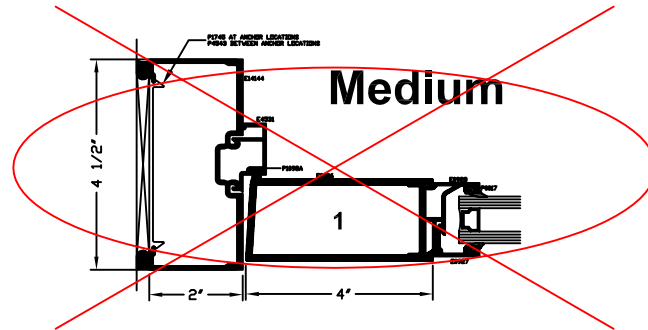
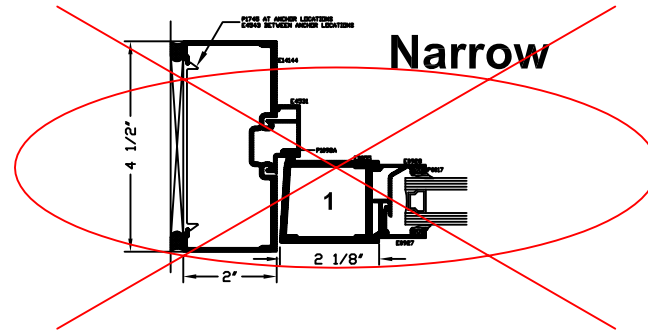
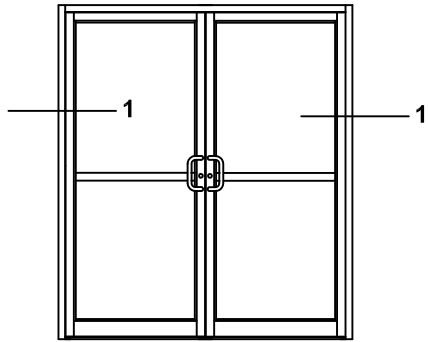

	<b>ATI</b>
Report #	<u>B3772-116-45</u>
Date	<u>10/20/2011</u>
Simulator	<u>Eric Bakula</u>

\*SEALANT, ROD, & ANCHORS NOT BY TUBELITE

# Standard Doors - Pairs 2" Frame Elevations & 1/4 Size Details

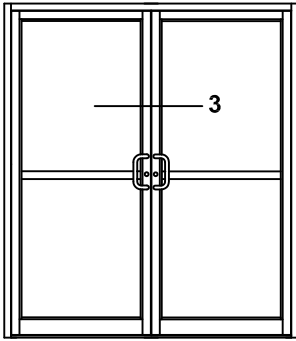

<b>ATI</b>	
<b>Report #</b>	<u>B3772-116-45</u>
<b>Date</b>	<u>10/20/2011</u>
<b>Simulator</b>	<u><i>Eric Barilko</i></u>

## Wide

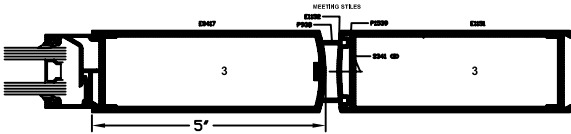

## Medium

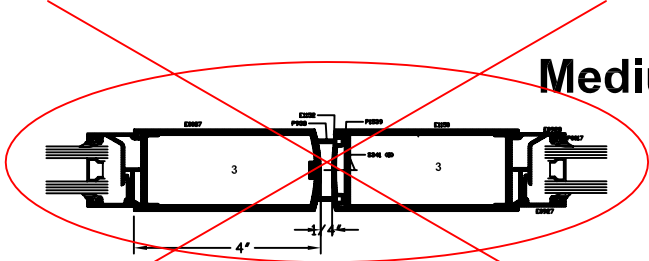

## Narrow

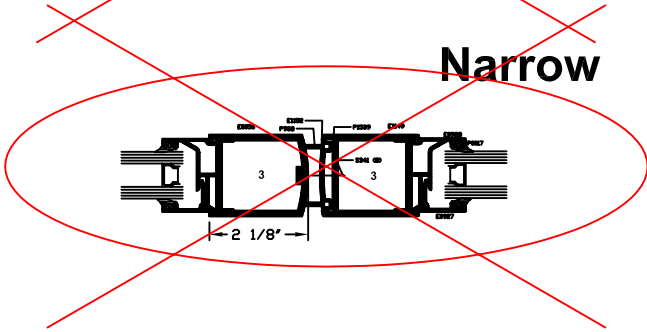

\*SEALANT, ROD, & ANCHORS NOT BY TUBELITE

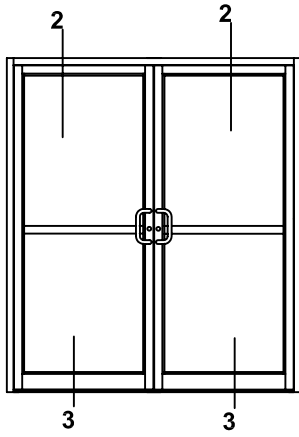

# Standard Doors - Pairs

## 2" Frame

### Elevations & 1/4 Size Details

**ATI**

Report # B3772-116-45

Date 10/20/2011

Simulator *Eric Barilko*

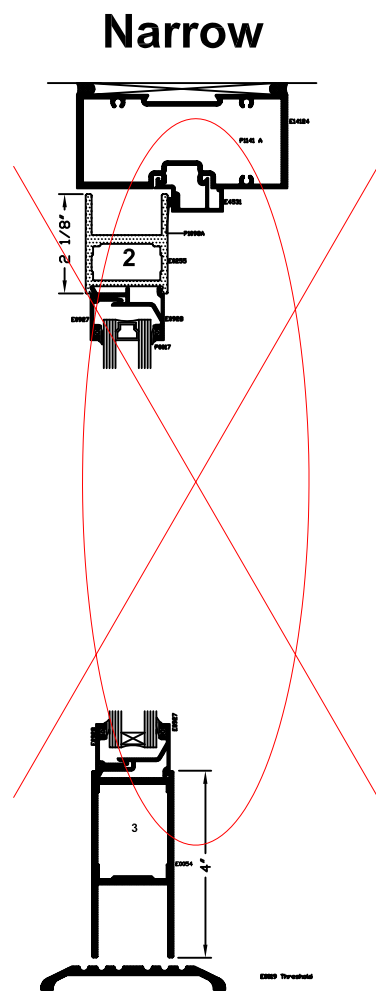
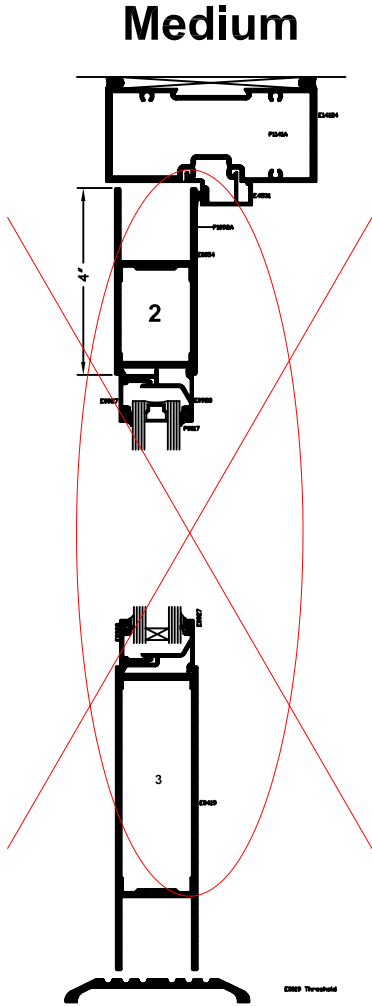
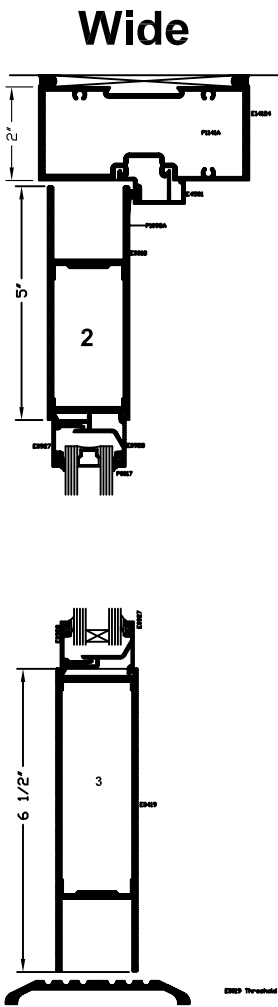

\*SEALANT, ROD, & ANCHORS NOT BY TUBELITE





E0318  
B

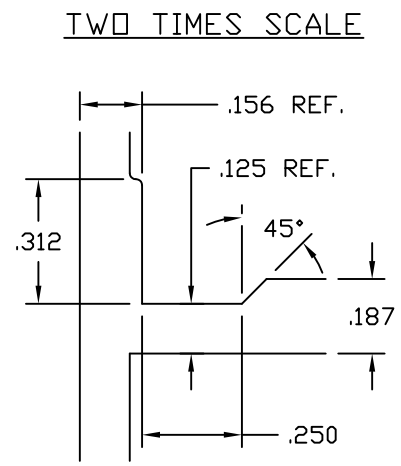
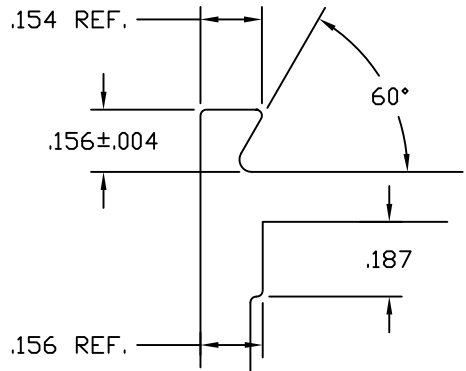
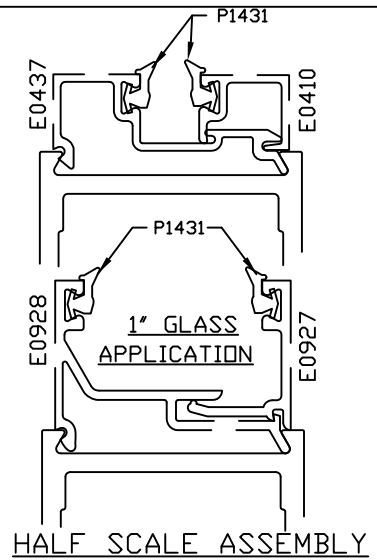
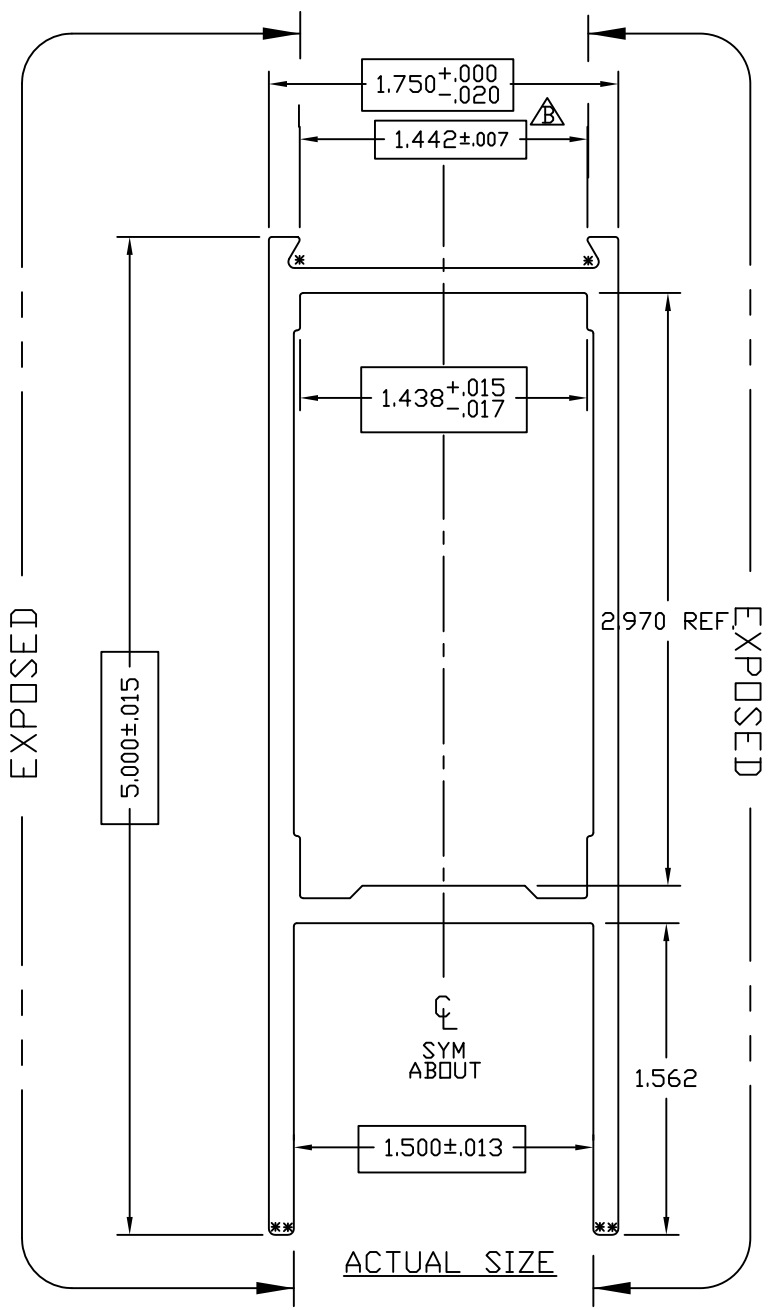

.125 +.003/-0.011 TYP WALL UNLESS NOTED  
SNAP FIT W/E0437(1/4"GLASS) AND E0928(1"GLASS)

© 2006 TUBELITE INC. ALL RIGHTS RESERVED  
ALUMINUM ASSOCIATION STANDARD TOLERANCES APPLY UNLESS NOTED  
ALL UNSPECIFIED RADII .015  
\* INDICATES .031 RADIUS

**TUBELITE**  
DEPENDABLE  
LEADERS IN ECO-EFFICIENT STOREFRONT, CURTAINWALL AND ENTRANCE SYSTEMS

3056 WALKER RIDGE NW, SUITE G  
WALKER, MICHIGAN 49544

WALL THK.	NOTED	SECTION CLASS	H	MAT'L	6063-T5	RATIO	32:1
PERIMETER OUT (TOTAL)	16.983(26.047)	AREA	1.708	WGT/FT	2.008		
FACTOR	13	CIRCLE SIZE	5.282	INFILL VOLUME	N/A		

RXX	.732	SXX	1.046	IXX	.916	CXX	.875
RYY	1.486	SYX	1.432	IYY	3.773	CYY	2.365

HORIZONTAL RAIL 5" X 1 3/4"  
CUSTOM DOORS/FRAME

DRAWN BY	DLH	DRWG DATE	04/26/84	APPV'D BY		DATE APPV'D	
DWG SCALE	NOTED	PRODUCT CODE	110	E0318		REV	B

REV	DATE	DESCRIPTION	INTL
A	11/07/00	+0.000/-0.010 WAS ±0.012	CRH
B	04/10/02	±0.007 WAS +0.000/-0.010	CRH

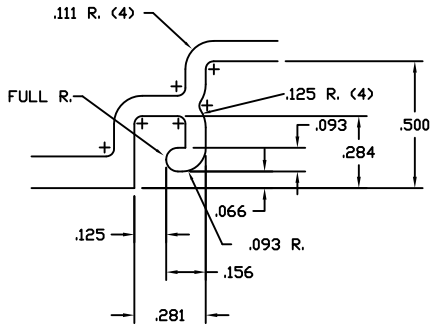

TWO TIMES SIZE

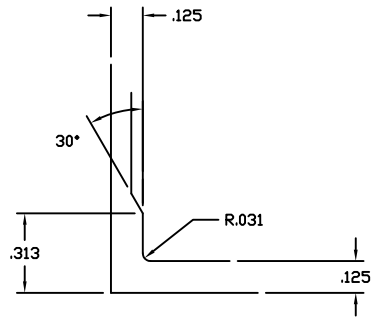

TWO TIMES SIZE

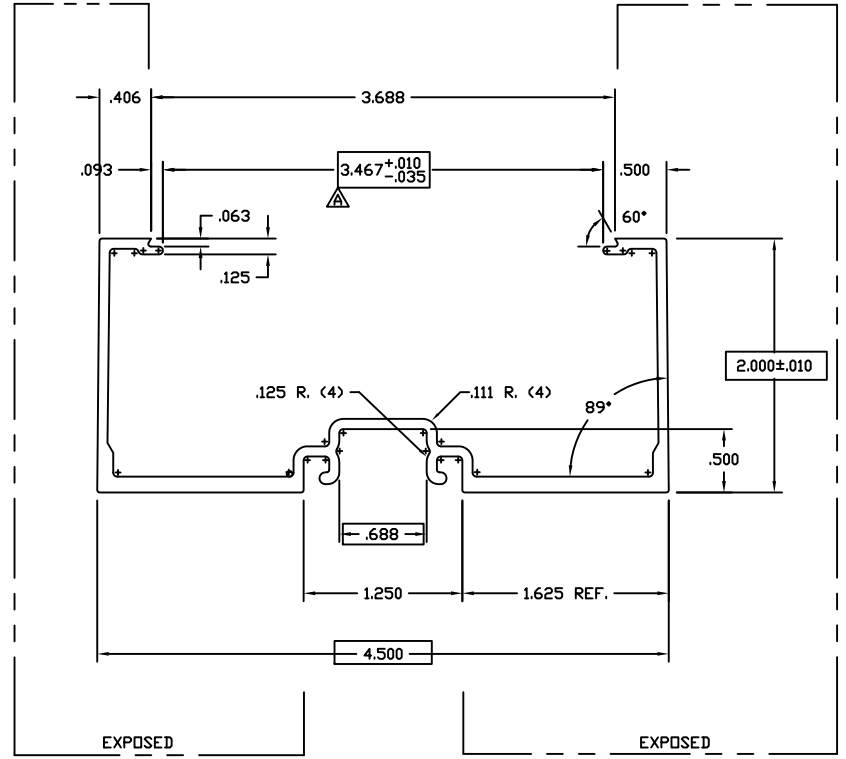

ACTUAL SIZE

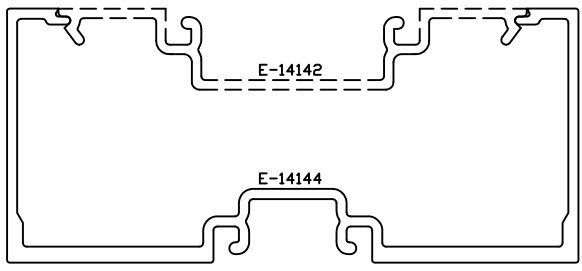

ASSEMBLY

ALSO MATES WITH E-4543 FLAT CLOSURE

©2006 TUBELITE INC. ALL RIGHTS RESERVED  
 ALUMINUM ASSOCIATION STANDARD TOLERANCES APPLY UNLESS NOTED  
 ALL UNSPECIFIED RADII .015  
 \* INDICATES .031 RADIUS  
 □ DENOTES CRITICAL DIMENSION  
 ALL DIES PROPERTY OF TUBELITE

**TUBELITE**  
 Dependable  
 LEADING IN ECO-FRIENDLY OPERATIONAL CURTAINWALL AND ENTRANCE SYSTEMS

3056 WALKER RIDGE NW, SUITE G  
 WALKER, MICHIGAN 49544

WALL THK.	.080	SECTION CLASS	S	MAT'L	6063-T5	RATIO	59:1
PERIMETER OUT (TOTAL)	21.100	AREA	1.001	WGT/FT	1.178		
FACTOR	19	CIRCLE SIZE	4.924	INFLLL VOLUME	N/A		
RXX	1.672	SXX	1.245	IXX	2.801	CXX	2.250
RYY	.643	SYY	.287	IYY	.414	CYY	1.444

**DOOR JAMB 2" X 4 1/2"**  
**E14000 NON THERMAL STOREFRONT**

DRAWN BY	KMH	DRWG DATE	05/13/93	APPV'D BY		DATE APPV'D	
DWG SCALE	NOTED	PRODUCT CODE	190		E14144		

REV	DATE	DESCRIPTION	INTL
	5-13-93	RELEASE TO TOOLING	RHH
	7-7-93	REVISE EXTR. # VAS E-14006	RHH
	7-29-93	RELEASE TO PRODUCTION	RHH
	10-28-96	REVISE EXTR. # E-14144 TO BE SYMMETRICAL	SRK
	12-12-96	RE-RELEASE TO PRODUCTION	SRK
A	03/28/07	REDUCED OPENING FOR BETTER FIT	NIK

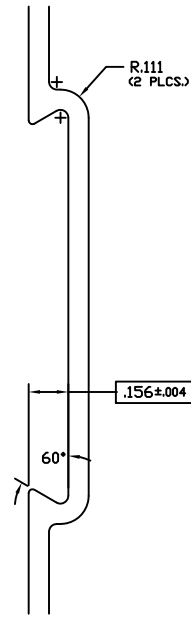

TWO TIMES SIZE

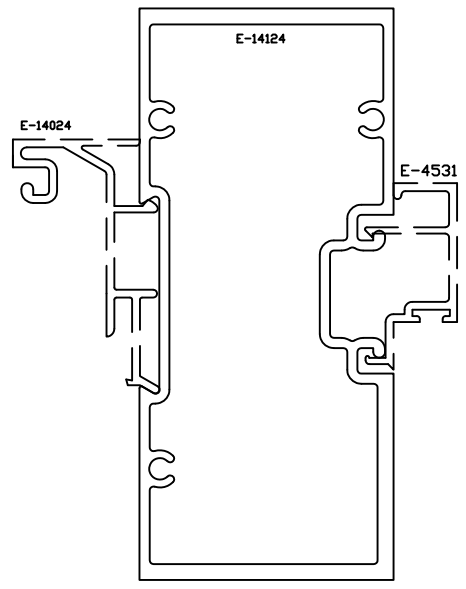

ASSEMBLY

MATES W/ E-4532, E-4026 & E-14024

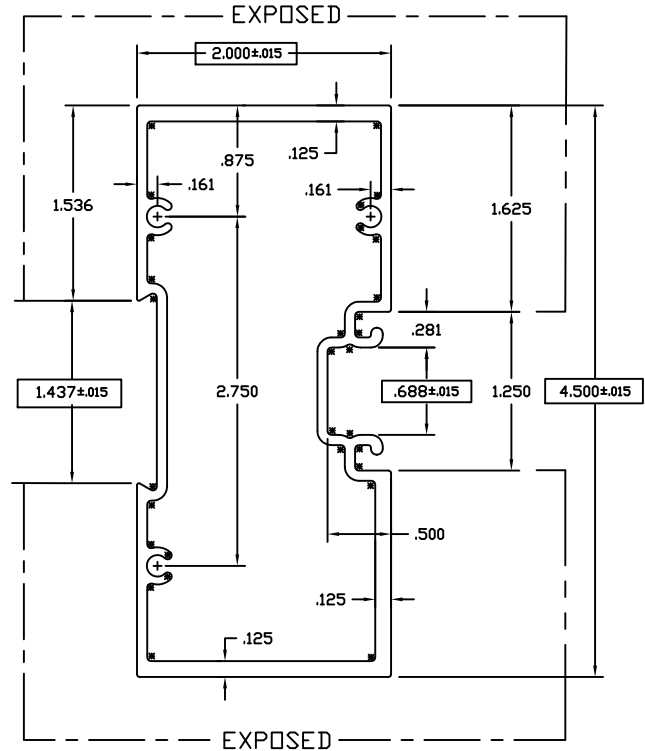

ACTUAL SIZE

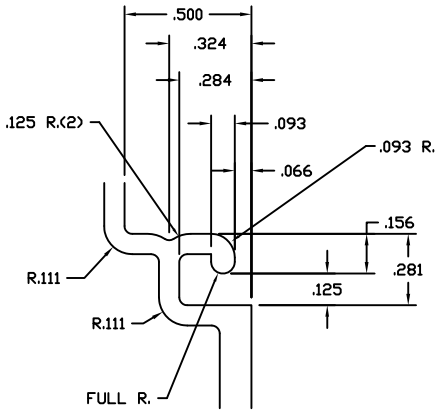

TWO TIMES SIZE

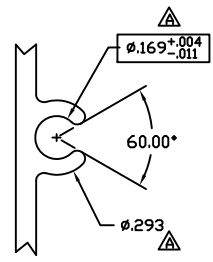

TWO TIMES SIZE

©2006 TUBELITE INC. ALL RIGHTS RESERVED  
ALUMINUM ASSOCIATION STANDARD  
TOLERANCES APPLY UNLESS NOTED

**TUBELITE**  
DEPENDABLE  
LEADER IN ECO-FRIENDLY OPERATING  
CURTAINWALL AND ENTRANCE SYSTEMS

3056 WALKER RIDGE NW, SUITE G  
WALKER, MICHIGAN 49544

WALL THK.	.080	SECTION H	MAT'L	6063-T5	RATIO	38:1	
PERIMETER OUT (TOTAL)	15.371(29.969)		AREA	1.464	WGT/FT	1.722	
FACTOR	17	CIRCLE SIZE	4.924	INFILL VOLUME	N/A		
RXX	1.601	SXX	1.640	IXX	3.751	CXX	2.287
RYY	.780	SYY	.849	IYY	.890	CYY	1.049

DENOTES CRITICAL DIMENSION  
 ALL DIES PROPERTY OF TUBELITE

REV	DATE	DESCRIPTION	INTL
	5-11-93	RELEASE TO TOOLING	KHM
	7-7-93	REVISE EXTR. # WAS E-14023	KHM
	7-28-93	RELEASE TO PRODUCTION	KHM
A	1/17/2011	J69 +.004/-0.011 was .162+/-0.004, .293 WAS .322	CRH

DOOR HEADER 2" X 4 1/2"  
E14000 NON THERMAL STOREFRONT

DRAWN BY	SMH	DRWG DATE	05/11/93	APPV'D BY		DATE APPV'D	
DWG SCALE	NOTED	PRODUCT CODE	190		E14124		REV
							A



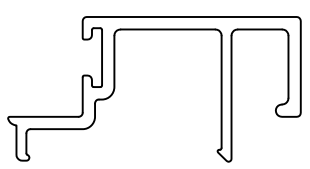
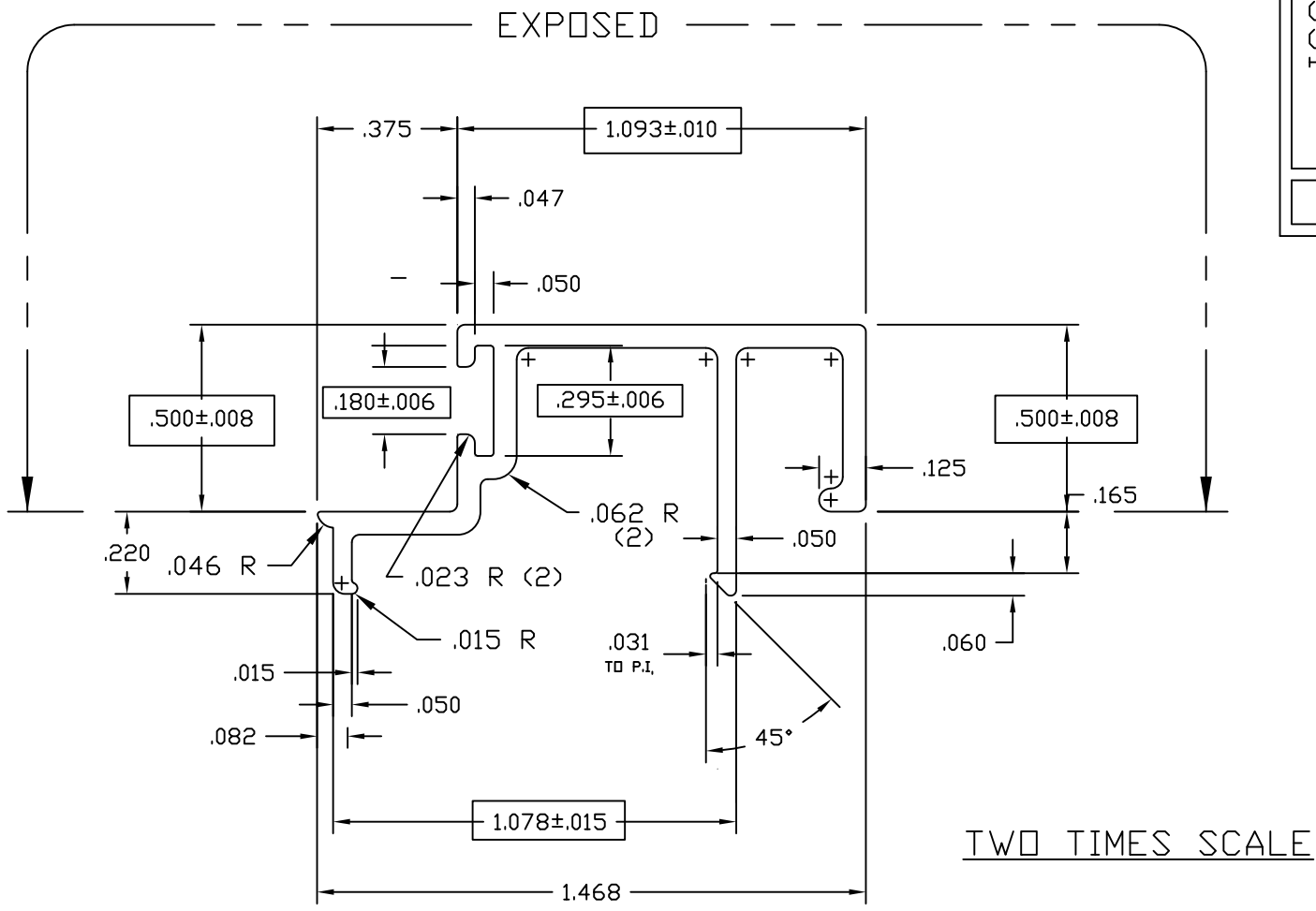

ACTUAL SIZE

USED WITH 4500 SERIES  
 REPLACES E-4510  
 USE WITH P-1098A WEATHERING

© 2006 TUBELITE INC. ALL RIGHTS RESERVED  
 ALUMINUM ASSOCIATION STANDARD  
 TOLERANCES APPLY UNLESS NOTED  
 ALL UNSPECIFIED RADII .015  
 \* INDICATES .031 RADIUS

**TUBELITE**  
 DEPENDABLE  
 LEADERS IN ECO-EFFICIENT STOREFRONT,  
 CURTAINWALL AND ENTRANCE SYSTEMS

3056 WALKER RIDGE NW, SUITE G  
 WALKER, MICHIGAN 49544

WALL THK.	.062	SECTION CLASS	S	MAT'L	6063-T5	RATIO	90
PERIMETER OUT (TOTAL)	6.966	AREA	.203	WGT/FT	.238		
FACTOR	29	CIRCLE SIZE	1.58	INFILL VOLUME	N/A		

RXX	.446	SXX	.049	IXX	.040	CXX	.824
RYY	.218	SYX	.021	IYY	.010	CYY	.461

DOOR STOP 1/2" X 1 3/32"  
 E4500 STOREFRONT

□ DENOTES CRITICAL DIMENSION  
 ALL DIES PROPERTY OF TUBELITE

REV	DATE	DESCRIPTION	INTL
	3/28/94	UPDATED SECTION PROPERTIES	TPB
	4/12/99	UPDATED EXPOSED	JEK

DRAWN BY	LS	DRWG DATE	02/07/85	APPV'D BY		DATE APPV'D	
DWG SCALE	NOTED	PRODUCT CODE	160	E4531		REV	







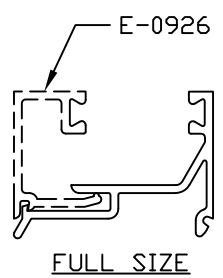
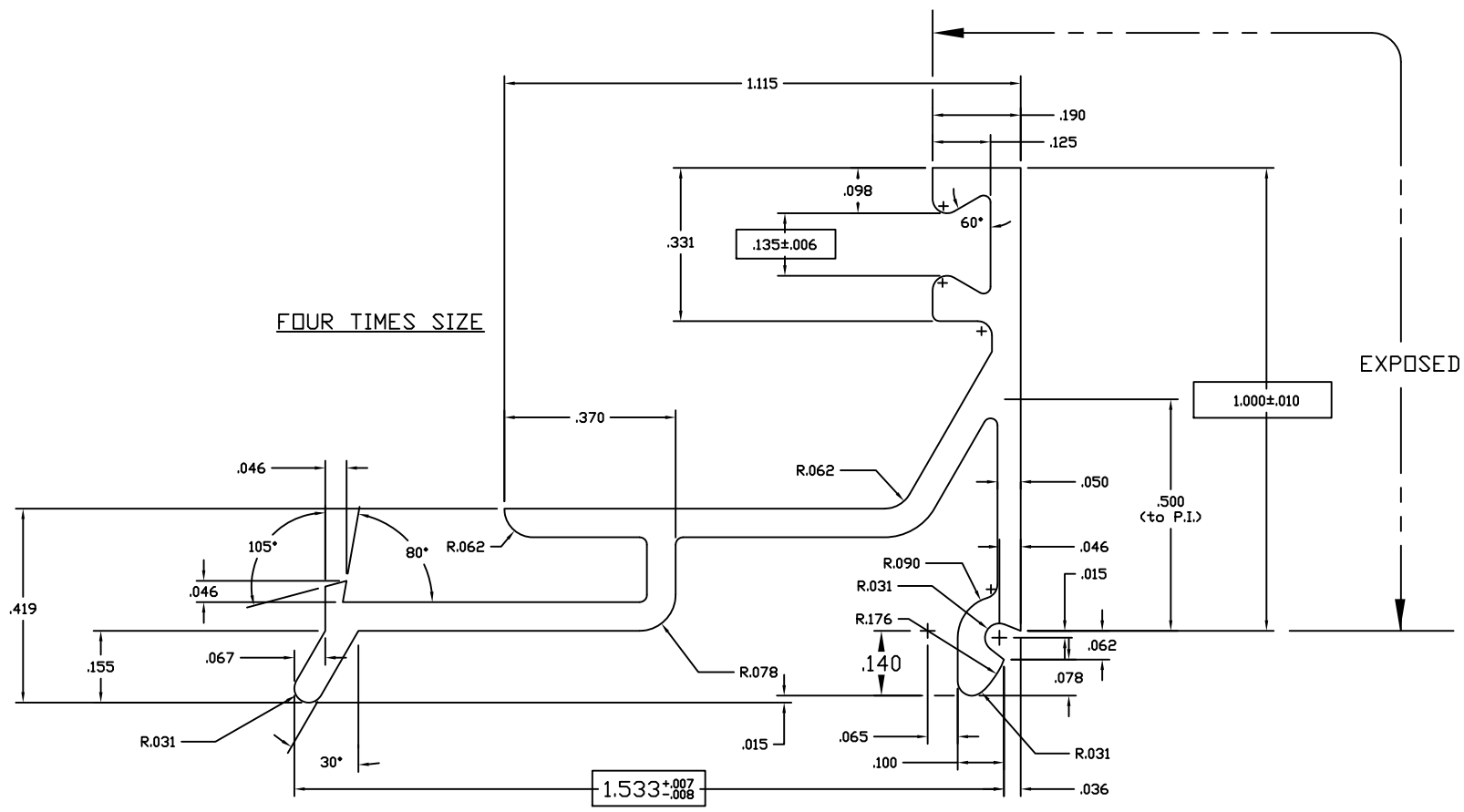

**NOTES:**

- 1) USE E-0927/0928 FOR 1" MAT'L
- 2) USE E-0926/0928 FOR 5/8" MAT'L
- 3) USE GLAZING BEAD P-302 FOR BOTH SIDES OF GLASS OR PANEL

©2006 TUBELITE INC. ALL RIGHTS RESERVED  
 ALUMINUM ASSOCIATION STANDARD TOLERANCES APPLY UNLESS NOTED  
 ALL UNSPECIFIED RADII .015  
 \* INDICATES .031 RADIUS  
 DENOTES CRITICAL DIMENSION  
 ALL DIES PROPERTY OF TUBELITE

**TUBELITE**  
 LEADING IN ECO-FRIENDLY OPERATING CURTAINWALL AND ENTRANCE SYSTEMS  
 3056 WALKER RIDGE NW, SUITE G  
 WALKER, MICHIGAN 49544

WALL THK	.062	SECTION CLASS	S	MAT'L	6063-T5	RATIO	59:1
PERIMETER OUT (TOTAL)	7.540	AREA	.234	WGT/FT	.275		
FACTOR	27	CIRCLE SIZE	1.938	INFILL VOLUME	N/A		
RXX	.302	SXX	.030	IXX	.021	CXX	.701
RYY	.501	SYX	.113	IYY	.059	CYY	1.049

GLASS STOP, 1" HIGH FOR 1" GLASS STOCK DOORS

DRAWN BY	DH	DRWG DATE	07/03/84	APPV'D BY		DATE APPV'D	
DWG SCALE	NOTED	PRODUCT CODE	100	E0928		REV	

E0927

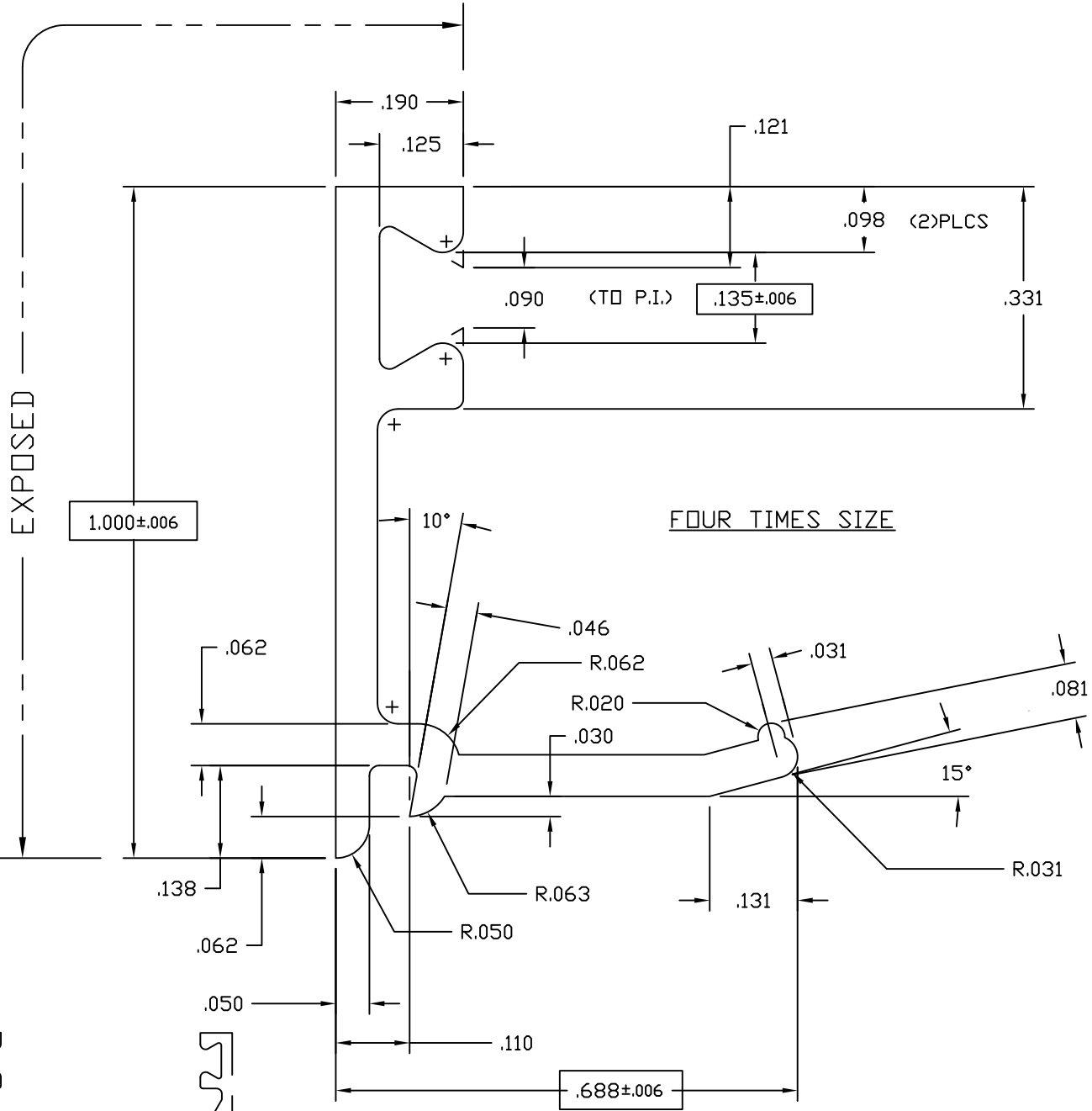

- NOTES:
- 1) USE WITH 1" INSULATED GLASS OR 1" PANEL
  - 2) USE GLAZING BEAD P-302 BOTH SIDES
  - 3) USE WITH E-0928 OR E-0929

© 2006 TUBELITE INC. ALL RIGHTS RESERVED  
 ALUMINUM ASSOCIATION STANDARD TOLERANCES APPLY UNLESS NOTED  
 ALL UNSPECIFIED RADII .015  
 \* INDICATES .031 RADIUS

**TUBELITE**  
 DEPENDABLE  
 LEADERS IN ECO-EFFICIENT STOREFRONT, CURTAINWALL AND ENTRANCE SYSTEMS

3056 WALKER RIDGE NW, SUITE G  
 WALKER, MICHIGAN 49544

WALL THK.	.062	SECTION CLASS	S	MAT'L	6063-T5	RATIO	74:1
PERIMETER OUT (TOTAL)	4.001	AREA	.124	WGT/FT	.146		
FACTOR	27	CIRCLE SIZE	1.120	INFILL VOLUME	N/A		

RXX	.321	SXX	.023	IXX	.013	CXX	.321
RYY	.185	SYY	.008	IYY	.004	CYY	.185

GLASS STOP, 1" HIGH FOR 1" GLASS STOCK DOORS

DRAWN BY	CRH	DRWG DATE	04/21/99	APPV'D BY		DATE APPV'D	
DWG SCALE	NOTED	PRODUCT CODE	100	E0927		REV	

REV	DATE	DESCRIPTION	INTL
X	xx/xx/xx	XXXXXXXXXXXXXXXX	XXX

FULL SIZE

FOUR TIMES SIZE

EXPOSED

E0419  
B

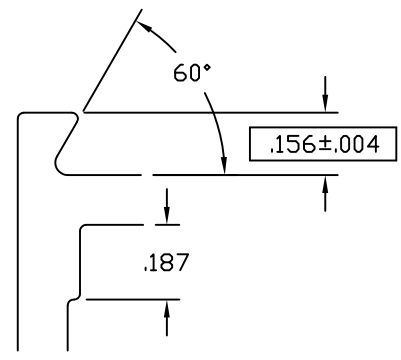
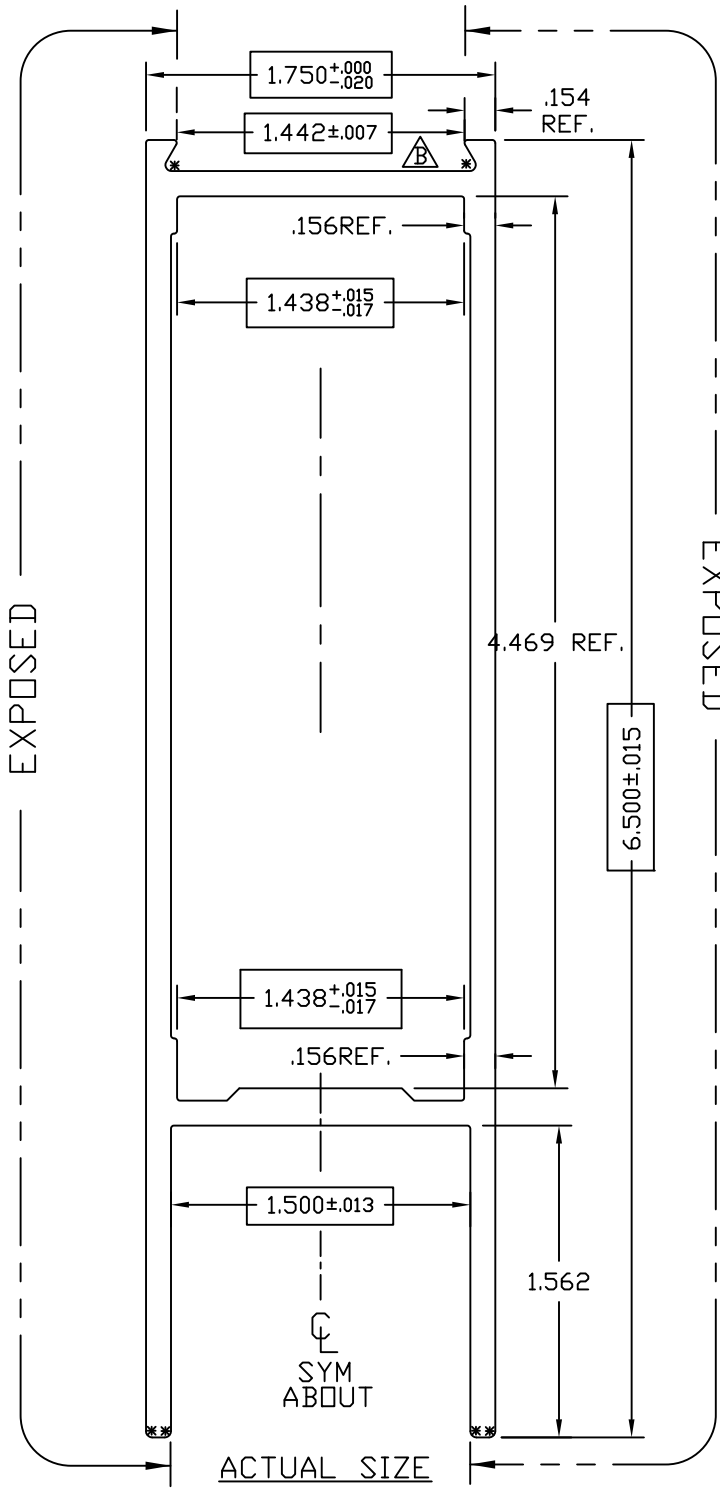

TWO TIMES SCALE

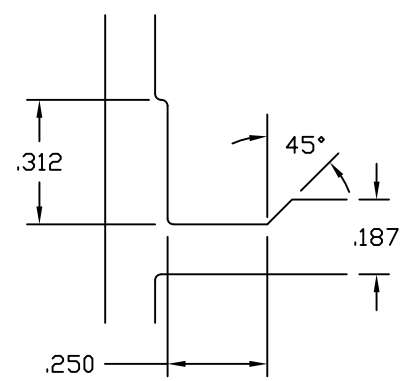

TWO TIMES SCALE

$.125^{+0.003}_{-.011}$  TYP WALL UNLESS NOTED

SNAP FIT W/E-0437

© 2006 TUBELITE INC. ALL RIGHTS RESERVED  
ALUMINUM ASSOCIATION STANDARD  
TOLERANCES APPLY UNLESS NOTED  
ALL UNSPECIFIED RADII .015  
\* INDICATES .031 RADIUS

**TUBELITE**  
DEPENDABLE  
LEADERS IN ECO-EFFICIENT STOREFRONT,  
CURTAINWALL AND ENTRANCE SYSTEMS

3056 WALKER RIDGE NW, SUITE G  
WALKER, MICHIGAN 49544

WALL THK.	NOTED	SECTION CLASS	H	MAT'L	6063-T5	RATIO	26:1
PERIMETER OUT (TOTAL)	19.959(26.440)		AREA	2.084	WGT/FT	2.451	
FACTOR	11	CIRCLE SIZE	6.720	INFILL VOLUME	N/A		

RXX	.747	SXX	1.330	IXX	1.164	CXX	.875
RYY	1.980	SYY	2.447	IYY	8.175	CYY	3.340

HORIZONTAL RAIL 6 1/2" X 1 3/4"  
CUSTOM DOORS/FRAMES

□ DENOTES CRITICAL DIMENSION  
ALL DIES PROPERTY OF TUBELITE

REV	DATE	DESCRIPTION	INTL
A	11/16/00	1.449 WAS 1.438	CRH
B	07/08/03	1.449 +/- .007 WAS 1.449 +.000/- .010	CRH

DRAWN BY	DH	DRWG DATE	04/19/84	APPV'D BY	CRH	DATE APPV'D	12/08/00
DWG SCALE	NOTED	PRODUCT CODE	110	E0419	REV	B	

E0417  
B

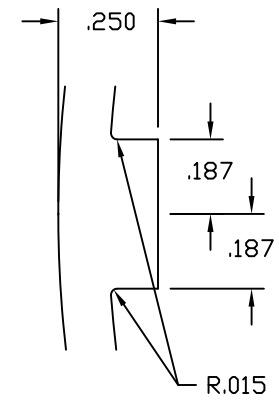

TWO TIMES SIZE

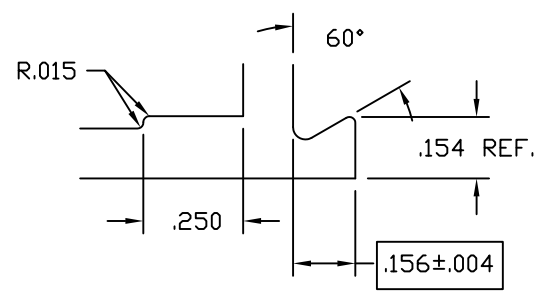

TWO TIMES SIZE

EXPOSED

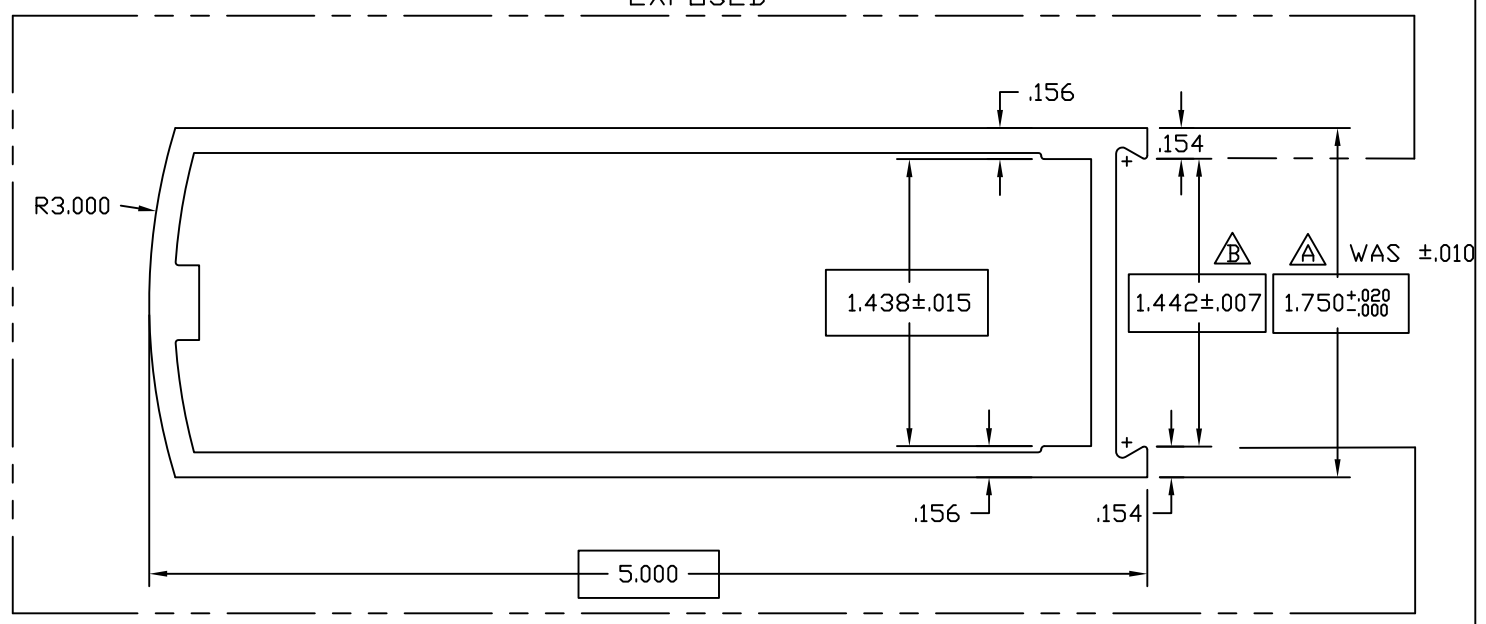

ACTUAL SIZE

$.125^{+.003}_{-.011}$  TYP WALL UNLESS NOTED

SNAP FIT W/E-0437

© 2006 TUBELITE INC. ALL RIGHTS RESERVED  
ALUMINUM ASSOCIATION STANDARD TOLERANCES APPLY UNLESS NOTED  
ALL UNSPECIFIED RADII .015  
\* INDICATES .031 RADIUS

**TUBELITE**  
DEPENDABLE  
LEADERS IN ECO-EFFICIENT STOREFRONT, CURTAINWALL AND ENTRANCE SYSTEMS

3056 WALKER RIDGE NW, SUITE G  
WALKER, MICHIGAN 49544

WALL THK.	NOTED	SECTION CLASS	H	MAT'L	6063-T5	RATIO	33:1
PERIMETER OUT (TOTAL)	13.679	(25.882)	AREA	1.661	WGT/FT	1.953	
FACTOR	13	CIRCLE SIZE	5.174	INFILL VOLUME	N/A		

RXX	.731	SXX	1.015	IXX	.888	CXX	.875
RYY	1.705	SYX	1.916	IYY	4.828	CYY	2.520

ROUND FACE VERTICAL RAIL 1 3/4" X 5"  
CUSTOM DOOR/FRAMES

DRAWN BY	DH	DRWG DATE	04/19/84	APPV'D BY		DATE APPV'D	
DWG SCALE	NOTED	PRODUCT CODE	110	E0417		REV	B

REV	DATE	DESCRIPTION	INTL
A	1/21/92	REVISE TOLERANCES	KMH
B	11/21/02	1.442 +/- .007 WAS 1.438 +.002/- .013	CRH

□ DENOTES CRITICAL DIMENSION  
ALL DIES PROPERTY OF TUBELITE

E0416  
D

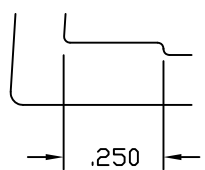

TWO TIMES SIZE

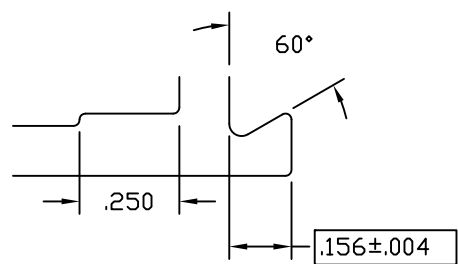

TWO TIMES SIZE

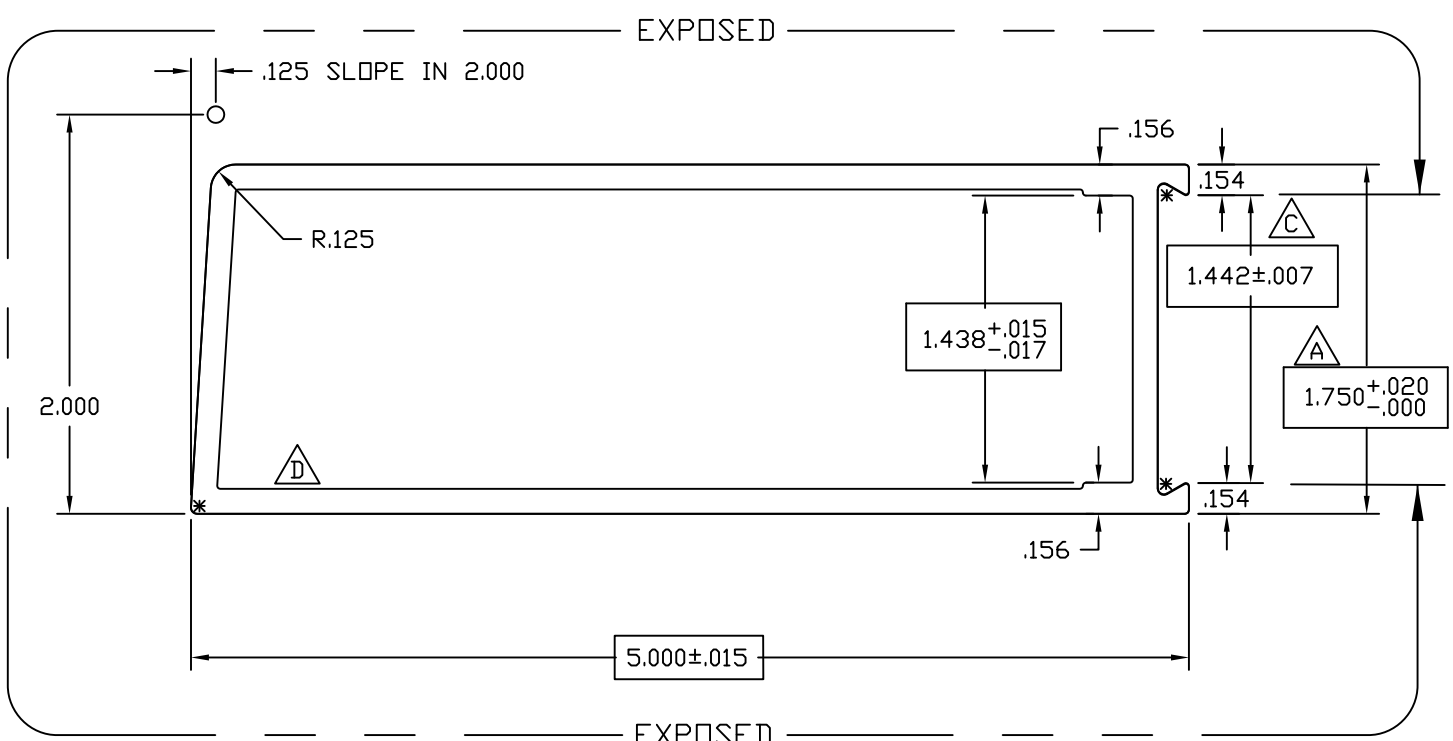

EXPOSED  
ACTUAL SIZE

$.125^{+.003}_{-.011}$  TYP WALL UNLESS NOTED

SNAP FIT W/E-0437

© 2006 TUBELITE INC. ALL RIGHTS RESERVED  
ALUMINUM ASSOCIATION STANDARD TOLERANCES APPLY UNLESS NOTED  
ALL UNSPECIFIED RADII .015  
\* INDICATES .031 RADIUS

**TUBELITE**  
DEPENDABLE  
LEADERS IN ECO-EFFICIENT STOREFRONT, CURTAINWALL AND ENTRANCE SYSTEMS

3056 WALKER RIDGE NW, SUITE G  
WALKER, MICHIGAN 49544

WALL THK.	NOTED	SECTION CLASS	H	MAT'L	6063-T5	RATIO	34:1
PERIMETER OUT (TOTAL)	13.733	AREA	1.623	WGT/FT	1.909		
FACTOR	13	CIRCLE SIZE	5.293	INFILL VOLUME	N/A		

RXX	.742	SXX	1.012	IXX	.893	CXX	.883
RYY	1.686	SYX	1.823	IYY	4.611	CYY	2.529

BEVELED VERTICAL RAIL 1 3/4" X 5"  
CUSTOM DOORS/FRAMES

DRAWN BY	DH	DRWG DATE	04/08/84	APPV'D BY		DATE APPV'D	
DWG SCALE	NOTED	PRODUCT CODE	110	E0416		REV	D

REV	DATE	DESCRIPTION	INTL
A	1/21/92	+0.020/-0.000 WAS +/-0.010	KMH
B	04/10/01	1.449 +0.000/-0.010 WAS 1.438 +0.002/-0.013	CRH
C	10/15/02	1.442+/-0.007 WAS 1.449 +0.000/-0.010	CRH
D	12/08/10	RMV .030 step in innser lower left corner	TT

□ DENOTES CRITICAL DIMENSION  
ALL DIES PROPERTY OF TUBELITE

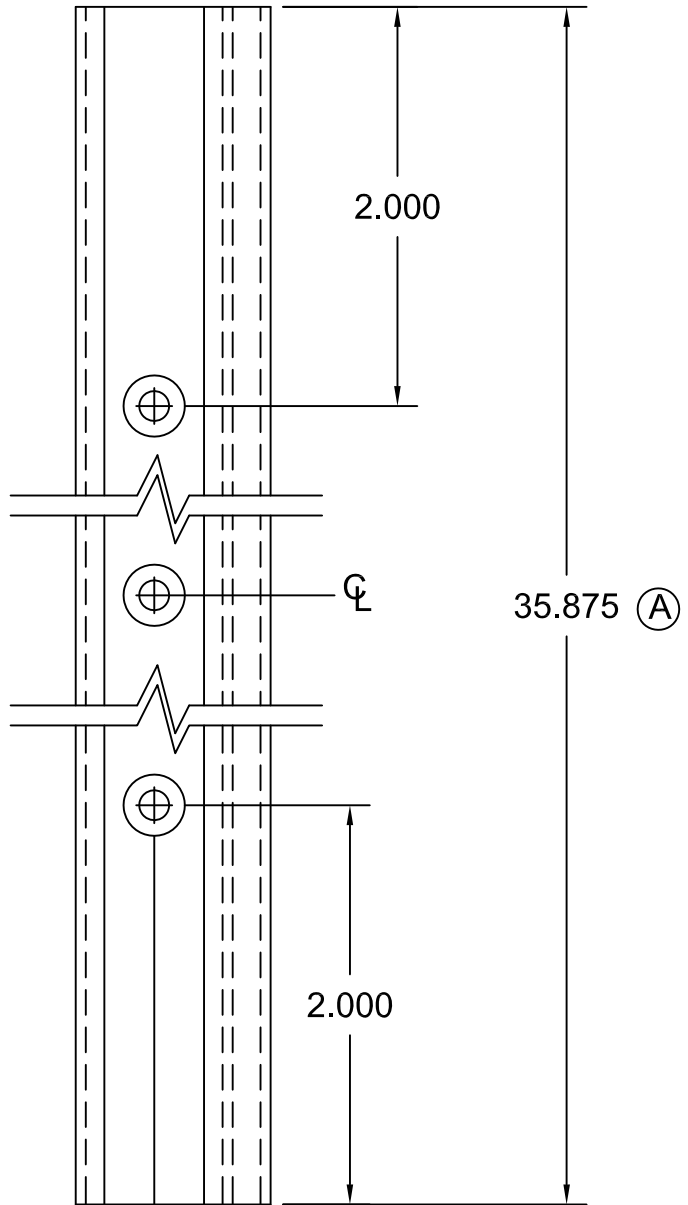

Operations:

1. Cut to length as required from E2059
2. Drill 3 holes with #25 Drl & Ctsk for S-064 (#6 FHCS)
3. Cut P-830 to length, Install, & Crimp ends
4. Cut P-914 to length, and install.
5. Paint ends as required
6. Ship with three (3) S064 Screws.

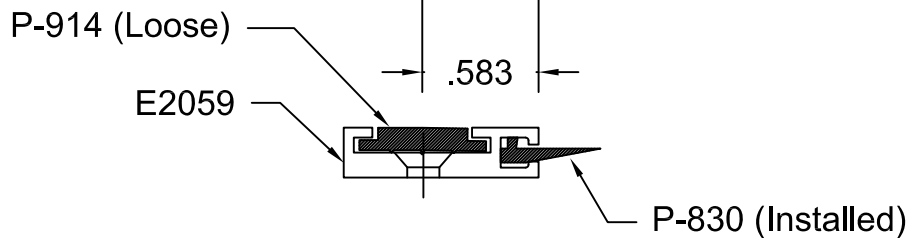

© 2006 TUBELITE INC. ALL RIGHTS RESERVED

ALL UNSPECIFIED RADII .015

\* INDICATES .031 RADIUS

□ DENOTES CRITICAL DIMENSION

**TUBELITE®**  
 DEPENDABLE  
 LEADERS IN ECO-EFFICIENT STOREFRONT,  
 CURTAINWALL AND ENTRANCE SYSTEMS

3056 WALKER RIDGE NW, SUITE G  
 WALKER, MICHIGAN 49544

REV	DATE	DESCRIPTION	INTL
	7/29/83	Released Part per ED 128	PJ
A	05/17/90	ED #1222 Dim was 34.875	KMH
B	8/24/01	Redrawn for CAD	DMT
C	06/19/03	OUTSOURCE - ADD S064 SCREWS	SRD

Door Seal to use with  
 E2058 Threshold

DRAWN BY PJ	DRWG DATE 05/09/83	APPV,D BY	DATE APPV'D
DRWG SCALE Full	PRODUCT CODE 380	<b>P1275</b>	REV C

P1098A

B

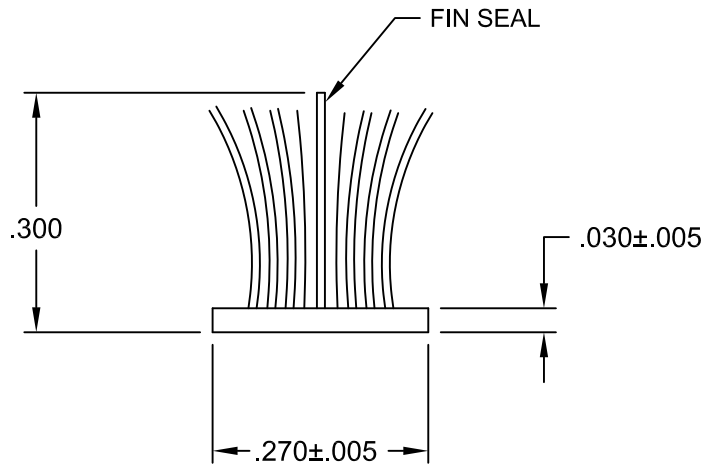

Actual Size

© 2006 TUBELITE INC. ALL RIGHTS RESERVED

ALL UNSPECIFIED RADII .015

\* INDICATES .031 RADIUS

□ DENOTES CRITICAL DIMENSION

**TUBELITE**  
 DEPENDABLE  
 LEADERS IN ECO-EFFICIENT STOREFRONT,  
 CURTAINWALL AND ENTRANCE SYSTEMS

3056 WALKER RIDGE NW, SUITE G  
WALKER, MICHIGAN 49544

REV	DATE	DESCRIPTION	INTL
A	03/08/83	Release Part per ED 109	
B	05/29/02	Redrawn for CAD	DMT

<p>Poly Bond Fin-Seal Weathering use with Door Stop E1377</p>			
DRAWN BY	Don H	DRWG DATE	06/03/83
APPV,D BY		DATE APPV'D	
DRWG SCALE	Noted	PRODUCT CODE	380
P1098A			REV B



Actual Size

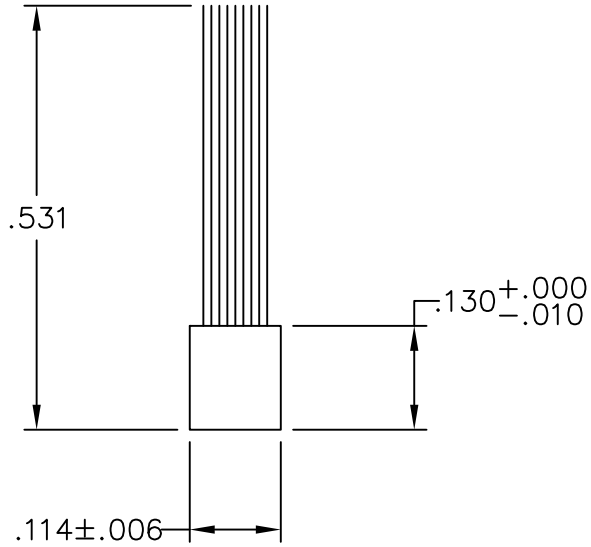

Four Times Size

Purchased Part

Schlege Pile Weathering  
Part Number 364-1006-5101

© 2006 TUBELITE INC. ALL RIGHTS RESERVED

ALL UNSPECIFIED RADII .015

\* INDICATES .031 RADIUS

□ DENOTES CRITICAL DIMENSION

**TUBELITE®**  
*DEPENDABLE*  
LEADERS IN ECO-EFFICIENT STOREFRONT,  
CURTAINWALL AND ENTRANCE SYSTEMS

3056 WALKER RIDGE NW, SUITE G  
WALKER, MICHIGAN 49544

REV	DATE	DESCRIPTION	INTL
A	05/03/02	Redrawn for CAD	DMT

Pile Weathering to use with E1195 and E1152			
DRAWN BY PJ	DRWG DATE 10/03/75	APPV,D BY	DATE APPV'D
DRWG SCALE Noted	PRODUCT CODE 110	P938	
			REV <b>A</b>



P914  
A

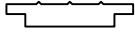

ACTUAL SIZE

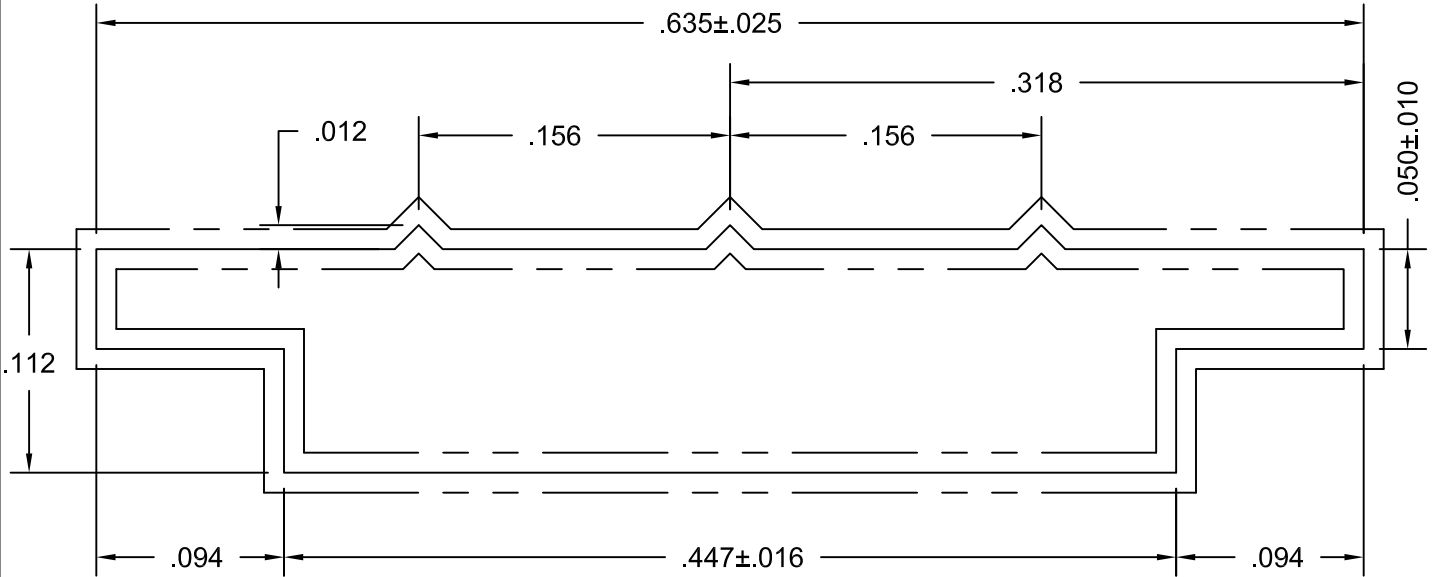

Ten Times Size

NOTE: Part to receive Silicone  
Bath after Extruding

Purchased Part  
Avon Rubber  
90 Durometer  
250' Rolls

© 2006 TUBELITE INC. ALL RIGHTS RESERVED

ALL UNSPECIFIED RADII .015

\* INDICATES .031 RADIUS

□ DENOTES CRITICAL DIMENSION

**TUBELITE**  
DEPENDABLE  
LEADERS IN ECO-EFFICIENT STOREFRONT,  
CURTAINWALL AND ENTRANCE SYSTEMS

3056 WALKER RIDGE NW, SUITE G  
WALKER, MICHIGAN 49544

REV	DATE	DESCRIPTION	INTL
A	01/19/96	Redrawn for AutoCAD	DMT

<p>EPDM Rubber Glazing Use with M1061, M1063, M1202</p>			
DRAWN BY	KMH	DRWG DATE	01/19/96
APPV,D BY		DATE APPV,D	
DRWG SCALE	Noted	PRODUCT CODE	380
		<b>P914</b>	REV <b>A</b>

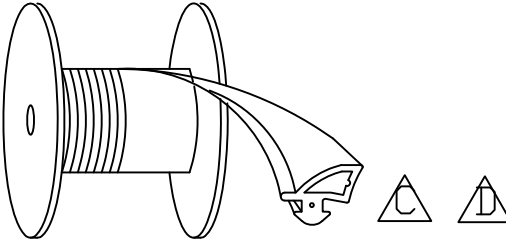

Material must  
UNREEL like this...

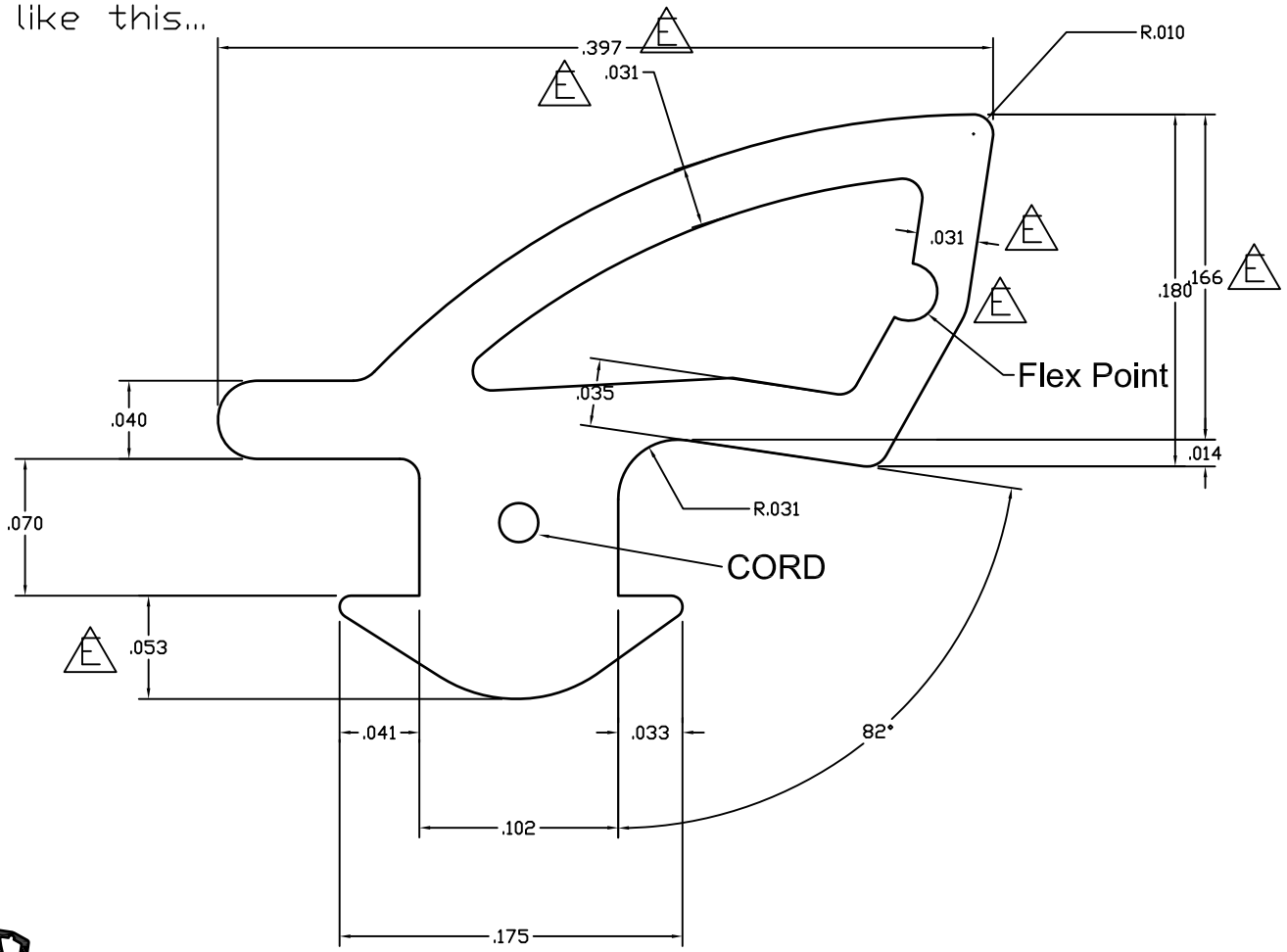

ACTUAL SIZE

MATERIAL: EPDM 60 DUROMETER WITH CORD

© 2006 TUBELITE INC. ALL RIGHTS RESERVED  
 ALL UNSPECIFIED RADII .015  
 \* INDICATES .031 RADIUS  
 □ DENOTES CRITICAL DIMENSION

**TUBELITE®**  
 DEPENDABLE  
 LEADERS IN ECO-EFFICIENT STOREFRONT,  
 CURTAINWALL AND ENTRANCE SYSTEMS

3056 WALKER RIDGE NW, SUITE G  
 WALKER, MICHIGAN 49544

REV	DATE	DESCRIPTION	INTL
A	08/20/07	MODIFIED DART: .070 WAS .060 AND .051 WAS .061 ADDED CORD	NIK
B	10/16/08	ADDED MANUFACTURER'S TOLERANCES FOR REFERENCE	SRD
C	10/22/10	Modified gasket position of how the reel should roll	TT
D	12/16/10	Modified gasket position of how the reel should roll	TT
E	02/15/11	Rev flex pt, thickness was .032, .180 was .188	TT

1/4"-1" DOOR GLAZING GASKET 500' ROLLS			
DRAWN BY NIK	DRWG DATE 4-17-07	APPV.D BY	DATE APPV'D
DRWG SCALE 10X	PRODUCT CODE 100	P0017	REV E