

# INT67

INT67 Interior Flush Glaze Framing allows easy incorporation of standard aluminum framing with 4-7/8" metal stud and drywall systems commonly used in commercial office and retail space. Multiple adapters are available in configurations for installing the aluminum frames after the drywall, completely covering the end of the stud wall.

Standard swing doors and frames provide a complete system and come in 11 anodized and 19 standard painted finishes. Gaskets for glass thicknesses from 1/4" to 3/4" are available in Black or Grey as desired. There is also an option for use of recycled aluminum on the storefront members [excludes doors and door frames].

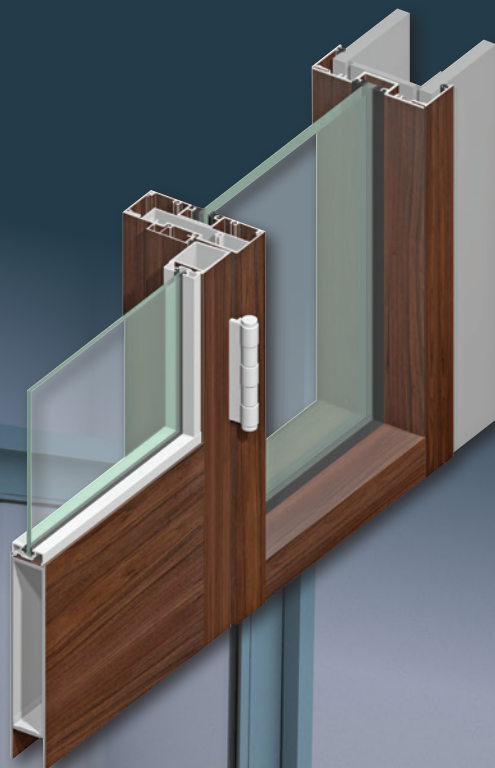

ALSO  
USED  
WITH

Standard Narrow  
Stile Entrances



**TUBELITE**<sup>®</sup>  
**DEPENDABLE**

LEADERS IN ECO-EFFICIENT STOREFRONT,  
CURTAINWALL AND ENTRANCE SYSTEMS

# INT67

## Storefront 5-1/2" Interior Flush Glaze Framing

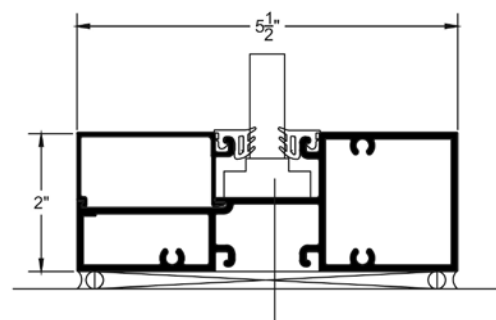
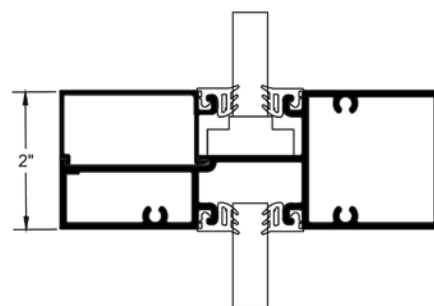
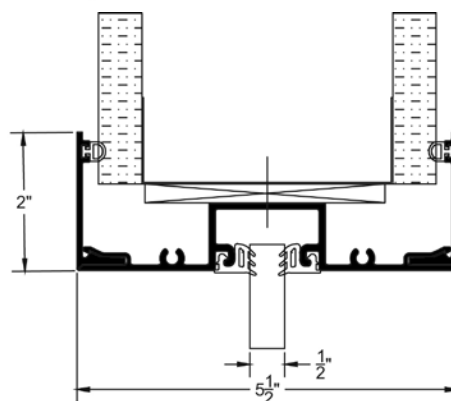
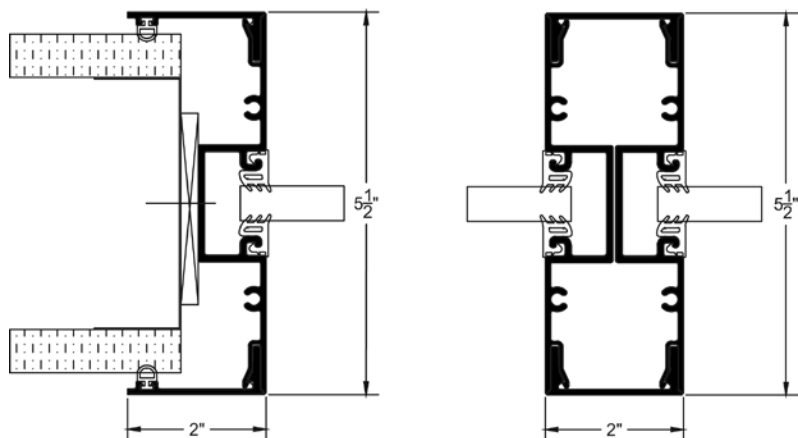

### System Features & Expected Performance

- System Profiles: 2" face x 5-1/2" depth.
- STC 31: 1/2" monolithic glass.\*
- STC 36: 1/2" laminated glass.\*
- System anchors only at the glass pocket .
- Bulb gaskets at interior exterior joint with drywall provides a uniform appearance and does not require sealant.
- Standard glazing for 1/2" glass with a broad range of options from 1/4" to 3/4".
- 5-1/2" depth can be used to capture a standard 4-7/8" perimeter wall.
- Stick fabricated with screw spline construction allows ordering material before exact openings are known.
- Options for knee wall conditions and channel Head and Sill.
- Can be used with Tubelite Standard Entrances.

\*Acoustic performance does not apply to doors.

DISCLAIMER: Tubelite takes no responsibility for product selection or application, including, but not limited to, compliance with building codes, safety codes, laws, merchantability or fitness for a particular purpose; and further disclaims all liability for the use, in whole or in part, of this Technical Guide in preparation of project specifications and/or other documents. Technical Guides are subject to change at any time, without notice, and at Tubelite's sole discretion. ©2020 Tubelite Inc.

041520

**TUBELITE**<sup>®</sup>  
DEPENDABLE

LEADERS IN ECO-EFFICIENT STOREFRONT,  
CURTAINWALL AND ENTRANCE SYSTEMS

# INT 67 INTERIOR FRAMING

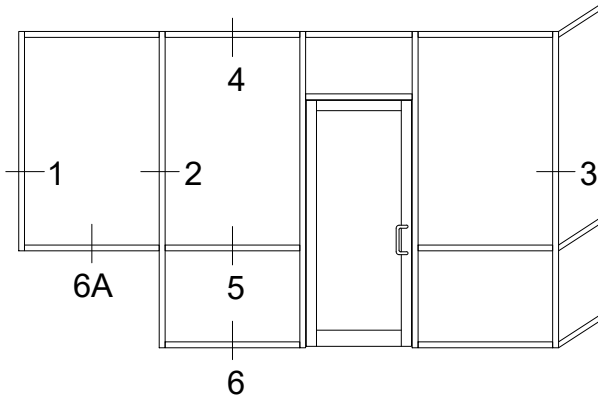

Tubelite reserves the right to change system configuration without prior notice when deemed necessary for product improvements.

Laws and building & safety codes governing the design and use of glazed entrance, window and curtain wall systems vary widely. Tubelite does not control the selection of product configurations, operating hardware or glazing materials, and assumes no responsibility thereof.

**Standard Details**  
1/4 scale

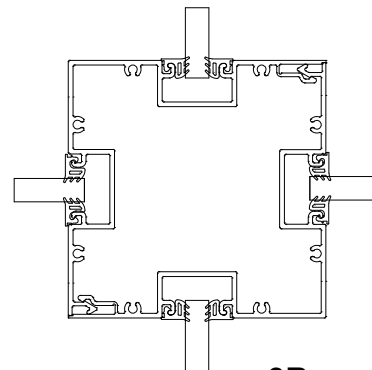
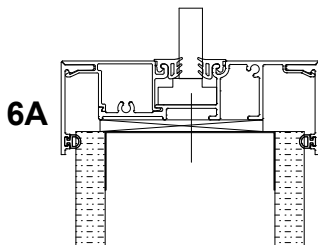
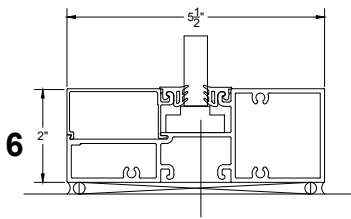
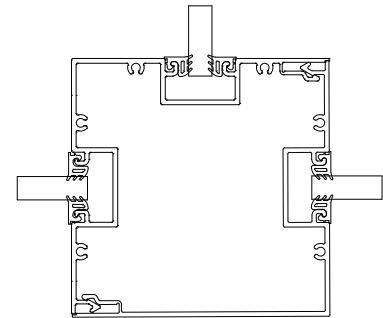
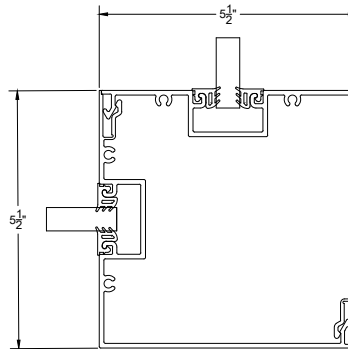
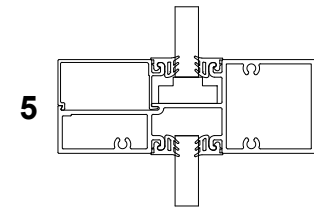
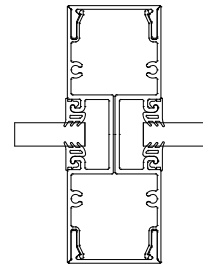
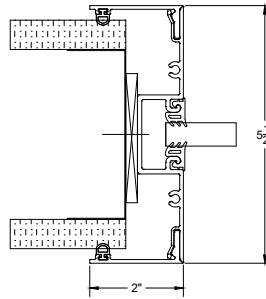
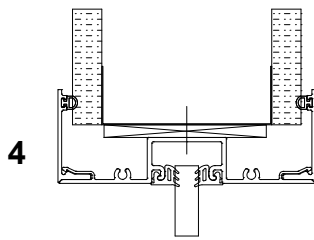

**TUBELITE®**  
DEPENDABLE  
LEADERS IN ECO-EFFICIENT STOREFRONT,  
CURTAINWALL AND ENTRANCE SYSTEMS

April 2020

For specific product applications, contact your Tubelite representative.  
Details on this page represent standard details found on our website.  
For more options, visit our website at [www.tubeliteinc.com/int-67](http://www.tubeliteinc.com/int-67)

# INT 67 INTERIOR FRAMING

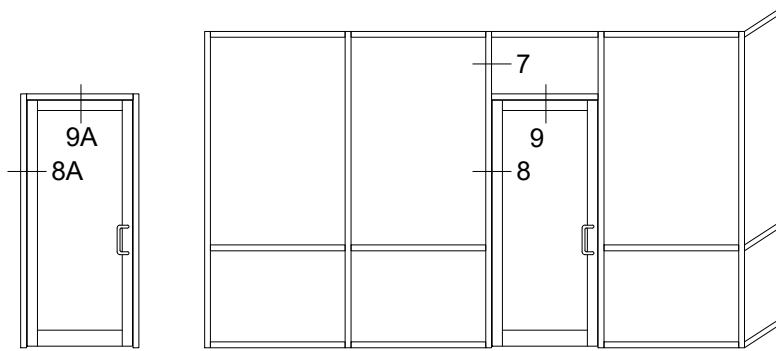

Tubelite reserves the right to change system configuration without prior notice when deemed necessary for product improvements.

Laws and building & safety codes governing the design and use of glazed entrance, window and curtain wall systems vary widely. Tubelite does not control the selection of product configurations, operating hardware or glazing materials, and assumes no responsibility thereof.

## Standard Details 1/4 scale

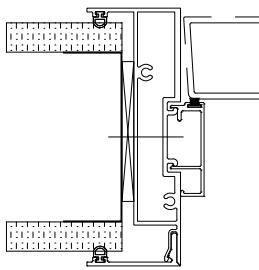

**8A**

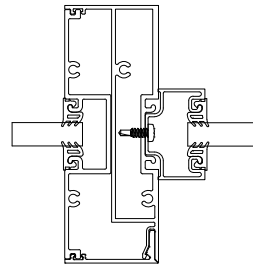

**7**

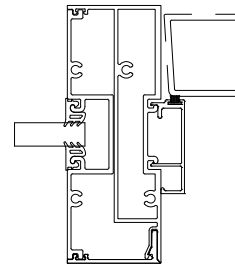

**8**

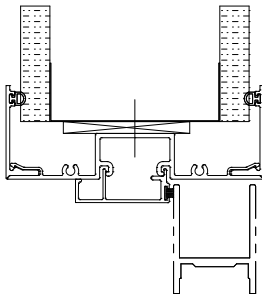

**9A**

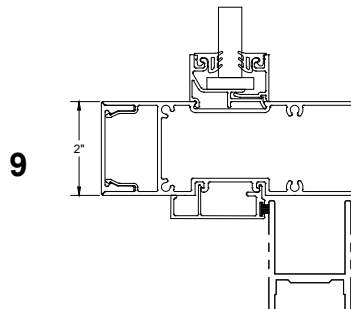

**9**

April 2020

**TUBELITE®**  
DEPENDABLE  
LEADERS IN ECO-EFFICIENT STOREFRONT,  
CURTAINWALL, AND ENTRANCE SYSTEMS

For specific product applications, contact your Tubelite representative.  
Details on this page represent standard details found on our website.  
For more options, visit our website at [www.tubeliteinc.com/int-67](http://www.tubeliteinc.com/int-67)