

TYPICAL ELEVATION

E34000 STORM STOREFRONT

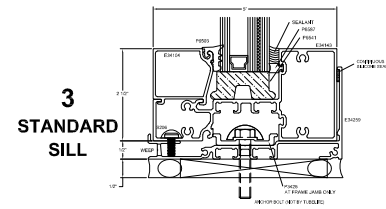

3
STANDARD
SILL

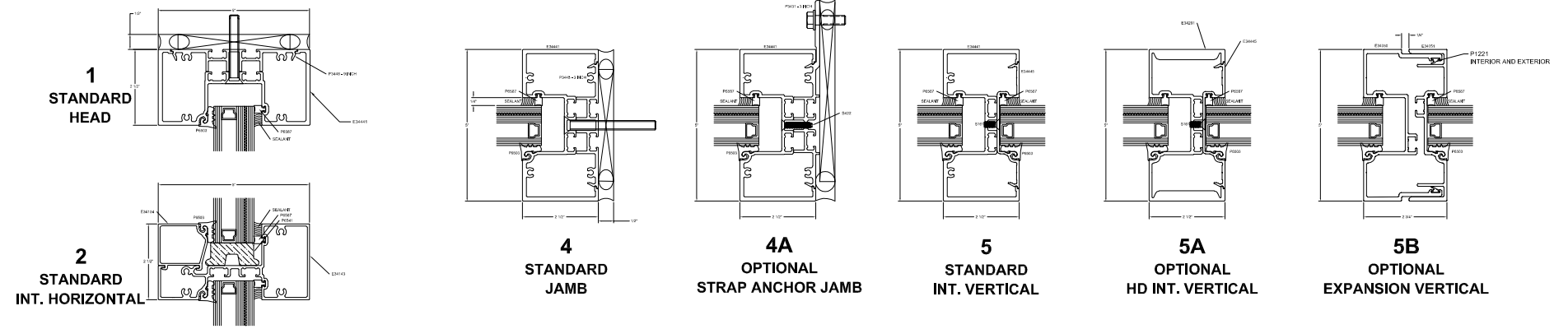
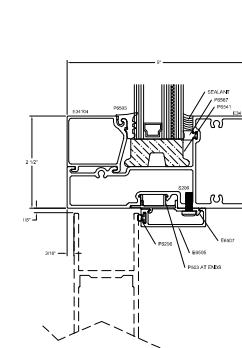

7
STANDARD
DOOR HEADER

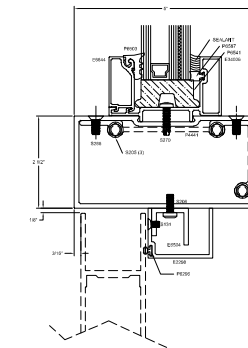

7A
OPTIONAL
DOOR HEADER

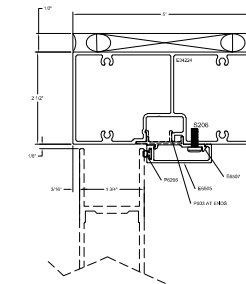

7B
OPTIONAL
NO TRANSOM DOOR HEAD

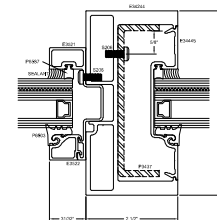

6
STANDARD
HD TRANSOM JAMB

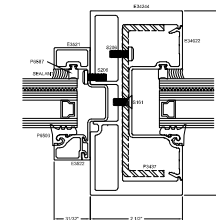

6A
OPTIONAL
HD DEEP POCKET
TRANSOM JAMB

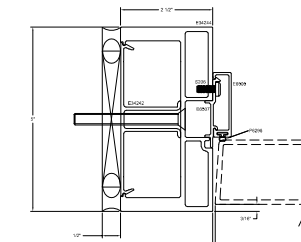

8A
STANDARD
HD DOOR JAMB

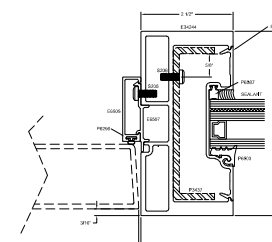

9
STANDARD
HD INT. DOOR JAMB

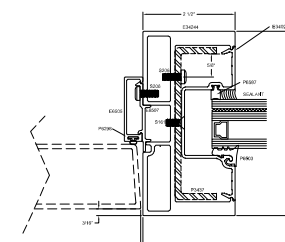

9A
OPTIONAL
HD INT. DOOR JAMB
DEEP POCKET

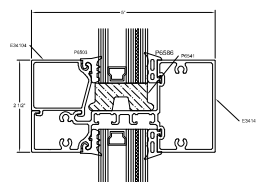

DRY GLAZE DETAIL

TUBELITE®

DEPENDABLE

LEADERS IN ECO-EFFICIENT STOREFRONT,
CURTAINWALL AND ENTRANCE SYSTEMS

Last Revised: 6/4/2021